

Given:

- Both static and dynamic (fatigue) failure criteria will be used.
- A minimum factor of safety =2 will be adhered to.
- For fatigue analysis the ASME elliptic model with Von Mises equivalent stress will be used

Assumptions:

- Chamber pressure = 500 psi
- Maximum chamber pressure fluctuations = 25% of mean chamber pressure [1]
- Thermal effects will initially be neglected because of short burn times and insulative properties of fuel grain (Temperature factor = 1)
- Loading is purely axial. (Size factor =1)

Find:

1) Pressure vessel analysis: (See Figure 1.0)

- Combustion chamber material is 6061 T6 aluminum OD = 2.35" Length = 8.00" THK= 0.140"
- Only use thin wall assumption if radius to thickness ratio = 20:1 [2]
- For static analysis find maximum tensile and shear stressed in plane and out of plane.
- *Calculate safety factor using given material properties
- For dynamic analysis use Von Mises equivalent stress with ASME elliptic
- Sigma alternating = 25% sigma mean [1]
- Find corrected endurance limit using correction coefficients as applicable to [2].

2) Forward bolted connection analysis: (See Figure 1.0)

- Material #1 = SS 316L annealed plate (0.205 inches thick)
- Material #2 = 6061 T6 aluminum (0.1875 inches thick)
- Assume reusable connection (75% of proof load)
- Use static and dynamic situations
- Use both bolt yielding and joint separation failure criteria
- Fatigue analysis – Von Mises equivalent stress, ASME elliptic, S.F. =2
- Assume bolts extend from nuts 2 threads
- No shanks on bolts

3) Aft bolted connection analysis: (See Figure 1.0)

- Material #2 = 6061 T6 aluminum (0.1875 inches thick)
- Material #2 = 6061 T6 aluminum (0.1875 inches thick)
- Assume reusable connection (75% of proof load)
- Use static and dynamic situations
- Use both bolt yielding and joint separation failure criteria
- Fatigue analysis – Von Mises equivalent stress, ASME elliptic, S.F. =2
- Assume bolts extend from nuts 2 threads
- No shanks on bolts

4) Flange to chamber weld analysis: (See Figure 1.0)

- Coming soon! Practicing TIG welding and learning more about weld quality.

References:

[1] NASA /TP -2000-209905

[2] "Mechanical Engineering Design", Shigley & Meschke 5th ed.

Section 1: Analysis of Forward Bolted Connection.

The forward bolted connection of the test motor is comprised of an annealed stainless steel plate connected to an aluminum plate by 8 M6 x 1.0 class 12.9 bolts. The values for the bolts are taken from Shigley and shown below.

Proof Strength:	$S_{pb} := 140 \times 10^3$ psi	
Ultimate Strength:	$S_{ub} := 177 \cdot 10^3$ psi	[2] pg. 343 Table 8-6
Yield Strength:	$S_{yb} := 160 \cdot 10^3$ psi	
Endurance Limit:	$S_{eb} := 27.5 \cdot 10^3$ psi	[2] pg. 353 Table 8-12
Threaded Area:	$A_{tb} := 3.12 \cdot 10^{-2}$ in ²	[2] pg.327 Table 8-1
Length of Bolt:	$L_b := 0.63$ in (16 mm)	
Diameter of Bolt:	$d_b := 0.236$ in (6mm)	
Modulus of Elasticity:	$E_b := 30 \cdot 10^6$ psi	

The nut and washer specs are given as:

Thickness of Nut:	$H_b := 0.20$ in (5.2 mm)	[2] pg.767 Table A-28
Thickness of Washers:	$W_t := 0.02$ in (0.5mm)	
Diameter of Washer:	$W_d := 0.5$ in	
Washer Modulus of Elasticity:	$E_w := 28 \cdot 10^6$ psi	

The Material properties for the SS 316L annealed stainless steel plate are taken from Matweb.com <http://www.matweb.com/search/SpecificMaterial.asp?bassnum=Q316A>

Thickness of Plate:	$SS_t := 0.205$ in
Modulus of Elasticity:	$E_{ss} := 28 \cdot 10^6$ psi

The material properties for the 6061 T6 aluminum plate are also taken from Matweb.com.
<http://www.matweb.com/search/SpecificMaterial.asp?bassnum=MA6016>

Thickness of Plate: $Al_t := 0.1875\text{in}$
 Modulus of Elasticity: $E_{al} := 10 \cdot 10^6 \text{psi}$

Section 2: Static Analysis of Bolts.

The maximum applied force to the grouping of bolts will occur when the maximum chamber pressure has been applied. For analysis a pressure of 625 psi will be used. This pressure acts over the the capped area shown in figure FB1.

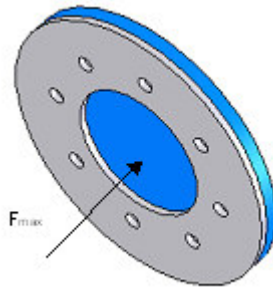

Figure FB1

The applied force is thus:

$$F_{\max} := (625\text{psi}) \cdot \left(\frac{\pi \cdot 2.07^2}{4} \cdot \text{in}^2 \right) \quad (1)$$

$$F_{\max} = 2.103 \times 10^3 \text{lbf}$$

Section 2.1: Stiffness of the Bolt

To examine how the bolted connection will react when an external load is applied the stiffness of the bolt, washer, and two plates must be examined.

The bolts used have no shank and thus the stiffness of the bolt is simply

$$k_b := \frac{A_{tb} \cdot E_b}{L_b} \quad (2) \text{ [2] pg. 337 eq. 8-10}$$

$$k_b = 1.486 \times 10^6 \frac{\text{lbf}}{\text{in}}$$

Section 2.2: Stiffness of the Members

To determine the stiffness of the washer and two plates the frustrum method outlined by Shigley will be used. With this method the diamond shaped area shown in the figure below is considered.

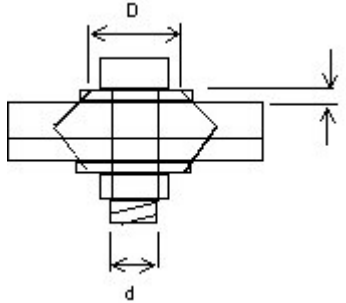

Figure FB2

For the washers and each of the plates a separate stiffness value k is determined and the total stiffness is determined in the same manner as springs in series. The equation for the individual frustrum is:

$$k_{\text{mem}} = \frac{0.577\pi \cdot E \cdot d}{\ln \left[\frac{(1.15 \cdot t + D - d)(D + d)}{(1.15t + D + d)(D - d)} \right]} \quad (3) \text{ [2] pg. 340 eq. 8-14}$$

Where d is the nominal diameter of the bolt, D is the shortest width of the frustrum, t is the thickness of the frustrum and E is Young's Modulus for the material being evaluated.

The frustrum starts at $D = 1.5d$ and grows at an angle of 30 degrees until it is at a maximum at a thickness equal to 1/2 the total grip. The grip is the total thickness of the clamped material. In this case the grip is equal to 0.55 inch (14mm).

By inspecting figure FB2 and following the geometry set out above the following values for the variables in equation (3) can be determined for each of the materials. By inserting these values into equation (3) the stiffness of each of the materials and thus the stiffness of the combined members can be calculated.

1) Washer: $d := 0.236 \text{ in}$

$D := 0.354 \text{ in}$

$$k_{\text{wash}} := 8.683 \cdot 10^7 \frac{\text{lbf}}{\text{in}}$$

$t := 0.0197 \text{ in}$

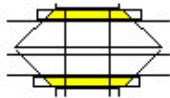

$E_w = 2.8 \times 10^7 \text{ psi}$

2) Steel Plate (1):

$$D := 0.377 \text{ in}$$

$$t := 0.256 \text{ in}$$

$$E_{ss} = 2.8 \times 10^7 \text{ psi}$$

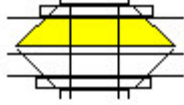

$$k_{ss1} := 1.629 \cdot 10^7 \frac{\text{lbf}}{\text{in}}$$

3) Steel Plate (2):

$$D := 0.5 \text{ in}$$

$$t := 0.149 \text{ in}$$

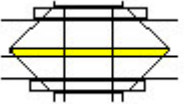

$$k_{ss2} := 4.118 \cdot 10^7 \frac{\text{lbf}}{\text{in}}$$

4) Aluminum Plate:

$$D := 0.377 \text{ in}$$

$$t := 0.187 \text{ in}$$

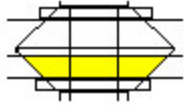

$$E_{al} = 1 \times 10^7 \text{ psi}$$

$$k_{al} := 6.828 \times 10^6 \frac{\text{lbf}}{\text{in}}$$

To find the equivalent stiffness of the members:

$$\frac{1}{k_{\text{mem}}} = \frac{1}{k_{\text{wash}}} + \frac{1}{k_{ss1}} + \frac{1}{k_{ss2}} + \frac{1}{k_{al}} + \frac{1}{k_{\text{wash}}}$$

$$\left(\frac{1}{k_{\text{wash}}} + \frac{1}{k_{ss1}} + \frac{1}{k_{ss2}} + \frac{1}{k_{al}} + \frac{1}{k_{\text{wash}}} \right)^{-1} = 3.919 \times 10^6$$

$$k_{\text{mem}} := 3.919 \times 10^6 \frac{\text{lbf}}{\text{in}}$$

Section 2.3: Bolt Strength and Joint Separation.

For static analysis and joint separation a constant C, called the Joint Constant must be defined. It's value can be used to determine joint separation and stress on the bolt.

$$C := \frac{k_b}{k_b + k_{\text{mem}}} \quad (4) [2] \text{ pg.347 eq. 8-21}$$

$$C = 0.275$$

Tensile Stress in the Bolt:

The proof strength of a bolt is the limiting factor for the allowable stress of the bolt. A load factor n , can be calculated that tells whether the bolt stress is less than the proof strength. A value of n greater than 1 indicates that the bolt stress is less than the proof strength.

$$n_p = \frac{S_p \cdot A_t - F_i}{C \cdot P} \quad (5) \text{ [2] pg. 347 eq. 8-23}$$

Here, P is the applied tensile load on one of the eight connections, and F_i is the preload of the bolt. For a reusable connection Shigley suggests a preload equal to 75% of the proof load which is defined as the product of the threaded area A_t , and the proof strength. However, after a complete analysis the factor of safety in fatigue was below the imposed minimum of 2 and a preload of 50% was decided upon. Therefore,

$$F_i := 0.50 A_{tb} \cdot S_{pb} \quad (6) \text{ [2] pg. 349 eqs. 8-25,26}$$

$$P := \frac{675}{8} \text{ psi}$$

Putting the above values into equation (6) a value for n may be determined.

$$n_p := \frac{S_{pb} \cdot A_{tb} - F_i}{C \cdot P}$$

$$n_p = 94.162$$

The bolts are loaded below their proof strengths. Even in the extreme case where the entire load is taken by one bolt we get an n value greater than unity.

Joint Separation:

If the internal pressure of the motor is great enough to cause separation between the Aluminum and Stainless steel plates within the connection the entire load would be placed on the bolts. The following equation returns a factor of safety against joint separation.

$$n_s := \frac{F_i}{P \cdot (1 - C)} \quad (7) \text{ [2] pg. 348 eq. 8-24}$$

$$n_s = 35.697$$

Again, we see that the connection is safe against joint separation and the external load will be shared between the bolts and the connected members.

Section 3: Fatigue Analysis of Bolts.

For fatigue analysis of the forward bolted section we first must find the mean and alternating stress in the bolt. To find this stress we use the equation:

$$\sigma_b = \frac{C \cdot P}{A_t} + \frac{F_i}{A_t} \quad (8) \text{ [2] pg. 347 eq. 8-22b}$$

The applied tensile load is to have a mean value of 500 psi and an alternating value of 125 psi. Again, this load will be taken up evenly by all eight bolts,

$$P_m := \frac{500}{8}$$
$$P_a := \frac{125}{8}$$

Because all of the other variables in equation (8) are independent of the applied load the value for the mean and alternating stress in the bolts can be determined.

$$\sigma_{bm} := \frac{C \cdot P_m}{A_{tb}} + \frac{F_i}{A_{tb}} \quad \sigma_{ba} := \frac{C \cdot P_a}{A_{tb}} + \frac{F_i}{A_{tb}}$$
$$\sigma_{bm} = 7.055 \times 10^4 \quad \sigma_{ba} = 7.014 \times 10^4$$

Using the ASME Elliptic criteria for fatigue safety the factor of safety for each of the bolts can be determined.

ASME Elliptic is of the form:

$$\left(\frac{n \cdot \sigma_{ba}}{S_e} \right)^2 + \left(\frac{n \cdot \sigma_{bm}}{S_y} \right)^2 = 1 \quad (9) \text{ [2] pg. 707 Table 18-1}$$

solving for n:

$$n_f := \frac{S_{yb} \cdot S_{eb}}{\sqrt{\sigma_{ba}^2 \cdot S_{yb}^2 + \sigma_{bm}^2 \cdot S_{eb}^2}}$$

$$n_f = 2.268$$

Section 4: Conclusion of Forward Bolted Analysis

The eight M6 x 1.0 class 12.9 bolts used in the forward connection were evaluated for tensile strength, separation, and fatigue. For each, the minimum required safety factor of two was exceeded. It is recommended that the bolt preload is 50% of the proof load to assure a satisfactory factor of safety for fatigue. A summary of important values is given below.

Maximum Applied Force	$F_{\max} = 2.103 \times 10^3 \text{ lbf}$
Bolt Preload:	$F_i = 2.184 \times 10^3 \text{ lbf}$
Mean Stress on Bolt	$\sigma_{\text{bm}} = 7.055 \times 10^4$
Alternating Stress on Bolt	$\sigma_{\text{ba}} = 7.014 \times 10^4$
Stiffness of Bolt	$k_b = 1.486 \times 10^6 \frac{\text{lbf}}{\text{in}}$
Stiffness of Members	$k_{\text{mem}} = 3.919 \times 10^6 \frac{\text{bf}}{\text{in}}$
Joint Constant	$C = 0.275$
Static Safety of Bolt	$n_p = 94.162$
Static Safety of Joint Separation	$n_s = 35.697$
Fatigue Factor of Safety of Bolt	$n_f = 2.268$

Section 5: Aft Bolted Connection.

The analysis of the aft bolted connection of the test motor will be analyzed for static, fatigue, and joint separation in the same manner as the forward bolted connection. The aft connection differs from the forward in that the steel plate has been substituted with another aluminum plate. The applied loading and fasteners remain the same.

Analysis for the aft bolted connection will begin with the determination of a new joint constant C which incorporates the changes in material. This new value will then be simply inserted into equations 5,7, and 8 from the sections above to determine the appropriate factors of safety.

Section 6: Stiffness of Aft Members.

Using the same method outlined in section 2.2 the stiffness of the aft members will be determined. Equation 3 is repeated here for reference.

$$k_{\text{mem}} = \frac{0.577\pi \cdot E_{\text{al}} \cdot d}{\ln \left[\frac{(1.15 \cdot t + D - d)(D + d)}{(1.15t + D + d)(D - d)} \right]} \quad (3) [2] \text{ pg. 340 eq. 8-14}$$

1) Washer:

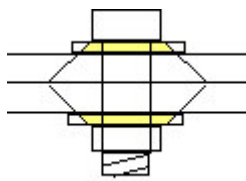

$$d := 0.236 \text{ in}$$

$$D := 0.354 \text{ in}$$

$$t := 0.0197 \text{ in}$$

$$E_w = 2.8 \times 10^7 \text{ psi}$$

$$k_{\text{wash}} := 8.683 \cdot 10^7 \frac{\text{lbf}}{\text{in}}$$

2) Aluminum:

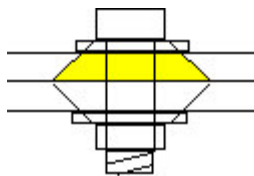

$$D := 0.377 \text{ in}$$

$$t := 0.1875 \text{ in}$$

$$E_{\text{al}} = 1 \times 10^7 \text{ psi}$$

$$k_{\text{al}} := 6.828 \times 10^6 \frac{\text{lbf}}{\text{in}}$$

Again the stiffnesses of the material are added in series resulting in an equivalent stiffness.

$$\left(\frac{1}{k_{\text{wash}}} + \frac{1}{k_{\text{al}}} + \frac{1}{k_{\text{al}}} + \frac{1}{k_{\text{wash}}} \right)^{-1} = 3.165 \times 10^6$$

$$k_{\text{aft.mem}} := 3.165 \times 10^6 \frac{\text{lbf}}{\text{in}}$$

Section 7: Determination of Joint Constant and Design Analysis.

Now that the new stiffness has been determined a joint constant for the aft connection can be determined. Equation 4, repeated here, is used to determine the joint constant.

$$C := \frac{k_b}{k_b + k_{\text{aft.mem}}} \quad (4) \text{ [2] pg.347 eq. 8-21}$$

$$C = 0.319$$

With the new joint constant static failure, joint separation and fatigue failure can be evaluated.

For static loading, the load factor n_p , can be calculated that tells whether the bolt stress is less than the proof strength. A value of n greater than 1 indicates that the bolt stress is less than the proof strength.

$$n_p := \frac{S_{pb} \cdot A_{tb} - F_i}{C \cdot P}$$

$$n_p = 81.026$$

We see here that the bolt is statically safe against failure.

The following equation returns a factor of safety against joint separation.

$$n_s := \frac{F_i}{P \cdot (1 - C)}$$

$$n_s = 38.035$$

Again, we see that the connection is safe against joint separation and the external load will be shared between the bolts and the connected members.

As in section 3 the fatigue analysis of the bolts used in the connection equation 8, repeated here, gives the stress acting on the bolt as a function of the joint constant, the applied mean and alternating loads, and the pre-load on the bolt. The mean and alternating stresses are analyzed using the ASME Elliptic criteria to determine a factor of safety against fatigue failure. Again the lower pre-load of 50% proof load will be used.

$$\sigma_b = \frac{C \cdot P}{A_t} + \frac{F_i}{A_t} \quad (8) \text{ [2] pg. 347 eq. 8-22b}$$

$$\sigma_{bm} := \frac{C \cdot P_m}{A_{tb}} + \frac{F_i}{A_{tb}} \qquad \sigma_{ba} := \frac{C \cdot P_a}{A_{tb}} + \frac{F_i}{A_{tb}}$$

$$\sigma_{bm} = 7.064 \times 10^4$$

$$\sigma_{ba} = 7.016 \times 10^4$$

$$n_f := \frac{S_{yb} \cdot S_{eb}}{\sqrt{\sigma_{ba}^2 \cdot S_{yb}^2 + \sigma_{bm}^2 \cdot S_{eb}^2}}$$

$$n_f = 2.265$$

The factor of safety for fatigue is satisfactory.

Section 8: Conclusion of Aft Connection Analysis.

The eight M6 x 1.0 class 12.9 bolts used in the aft connection were evaluated for tensile strength, separation, and fatigue. For each, the minimum required safety factor of two was exceeded. It is recommended that the bolt preload is 50% of the proof load to assure a satisfactory factor of safety for fatigue. A summary of important values is given below.

Maximum Applied Force	$F_{max} = 2.103 \times 10^3 \text{ lbf}$
Bolt Preload:	$F_i = 2.184 \times 10^3 \text{ lbf}$
Mean Stress on Bolt	$\sigma_{bm} = 7.064 \times 10^4$
Alternating Stress on Bolt	$\sigma_{ba} = 7.016 \times 10^4$
Stiffness of Bolt	$k_b = 1.486 \times 10^6 \frac{\text{lbf}}{\text{in}}$
Stiffness of Members	$k_{mem} = 3.919 \times 10^6 \frac{\text{bf}}{\text{in}}$
Joint Constant	$C = 0.319$
Static Safety of Bolt	$n_p = 81.026$
Static Safety of Joint Separation	$n_s = 38.035$
Fatigue Factor of Safety of Bolt	$n_f = 2.265$

