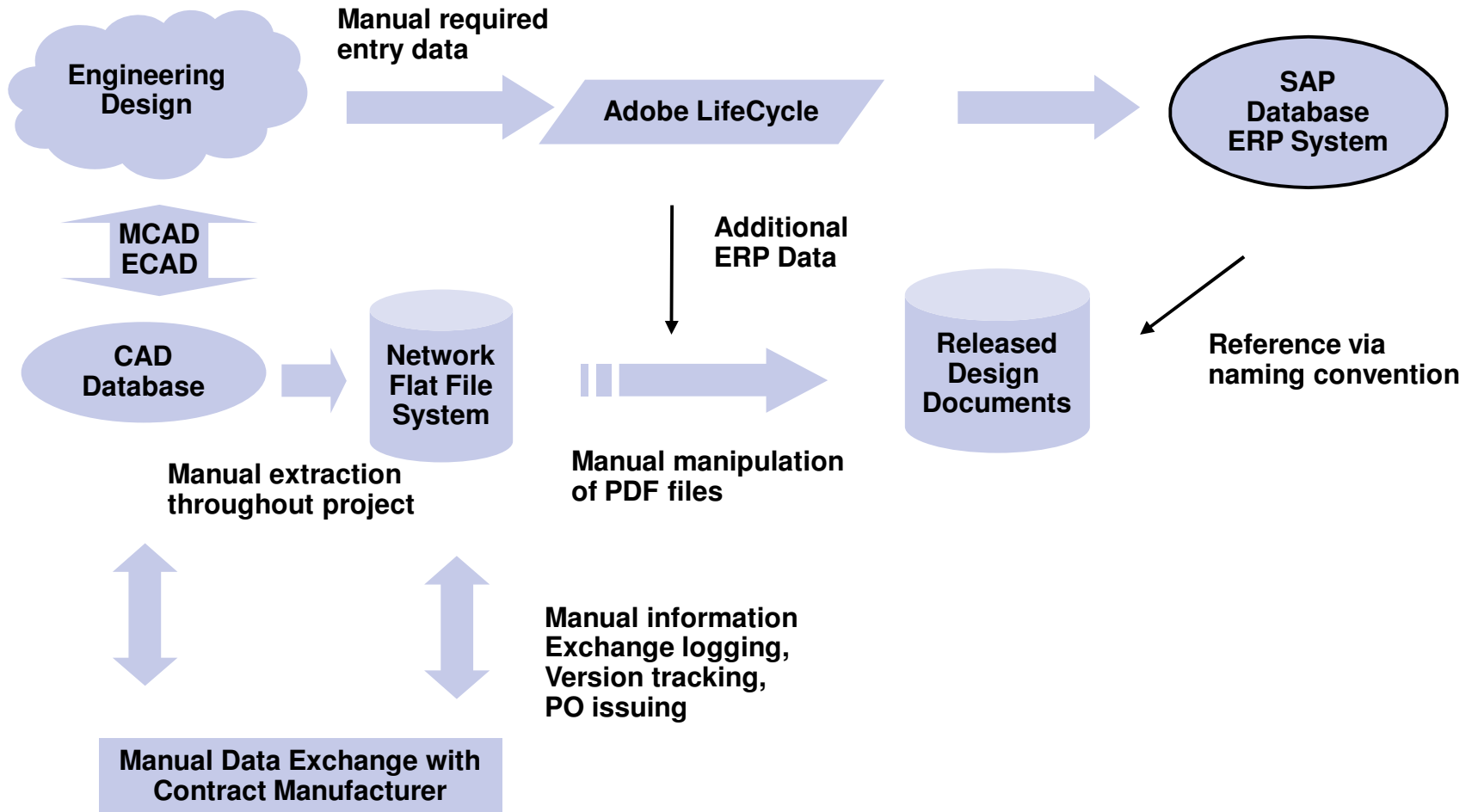

PDMLink/ProjectLink Uniqueness Solution

Focused on WTPart, WTDocument and
EPMDocument

Objective

A “to be” vision of a complete business system encapsulating ERP and PLM systems in COM DEV.

Current Process



Process After Stage 2 with PLM

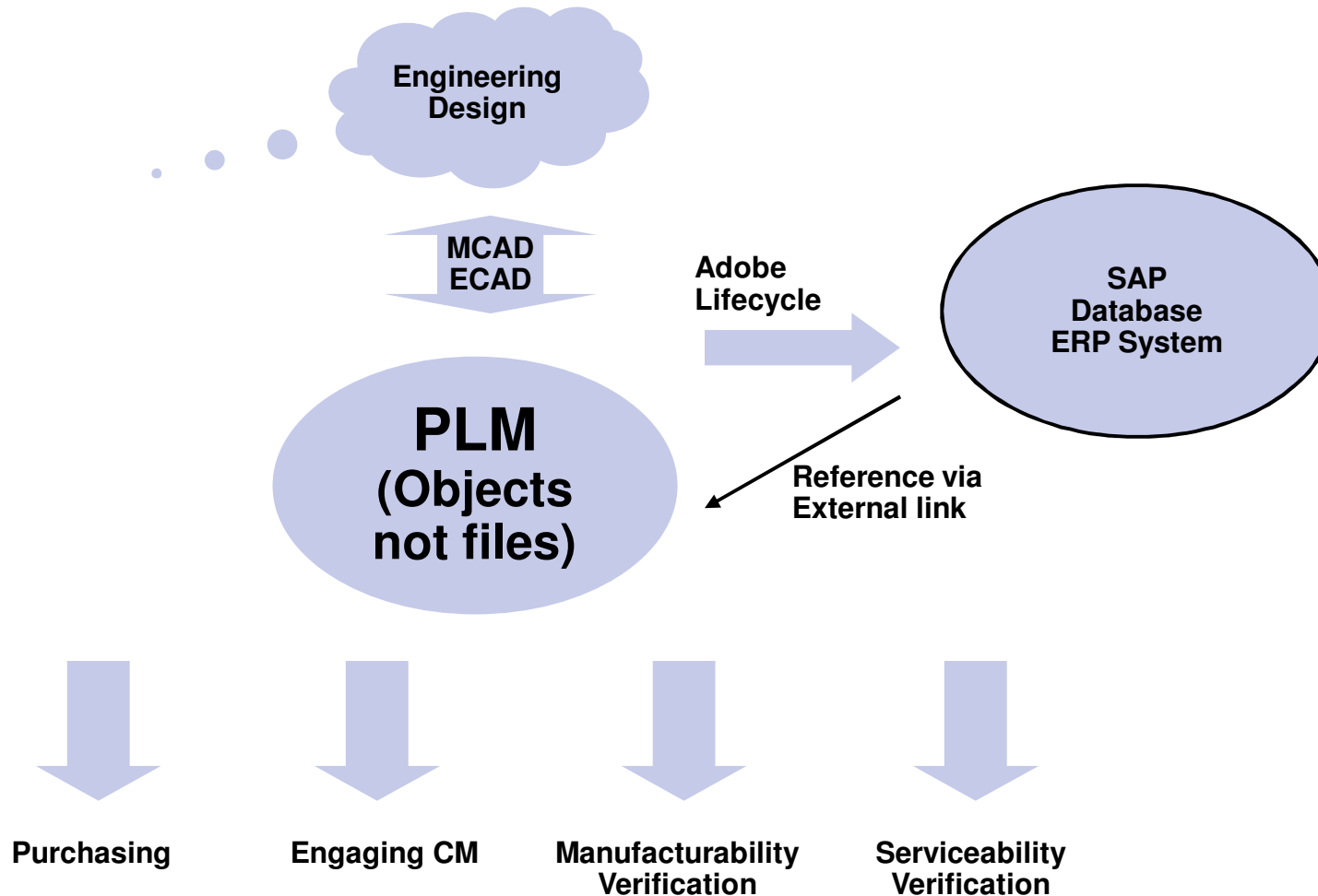

Completely in Sync with PTC Vision

Digital Product Value Chain

Where the most impactful product decisions are made, features and cost determined, suppliers and materials locked-in.

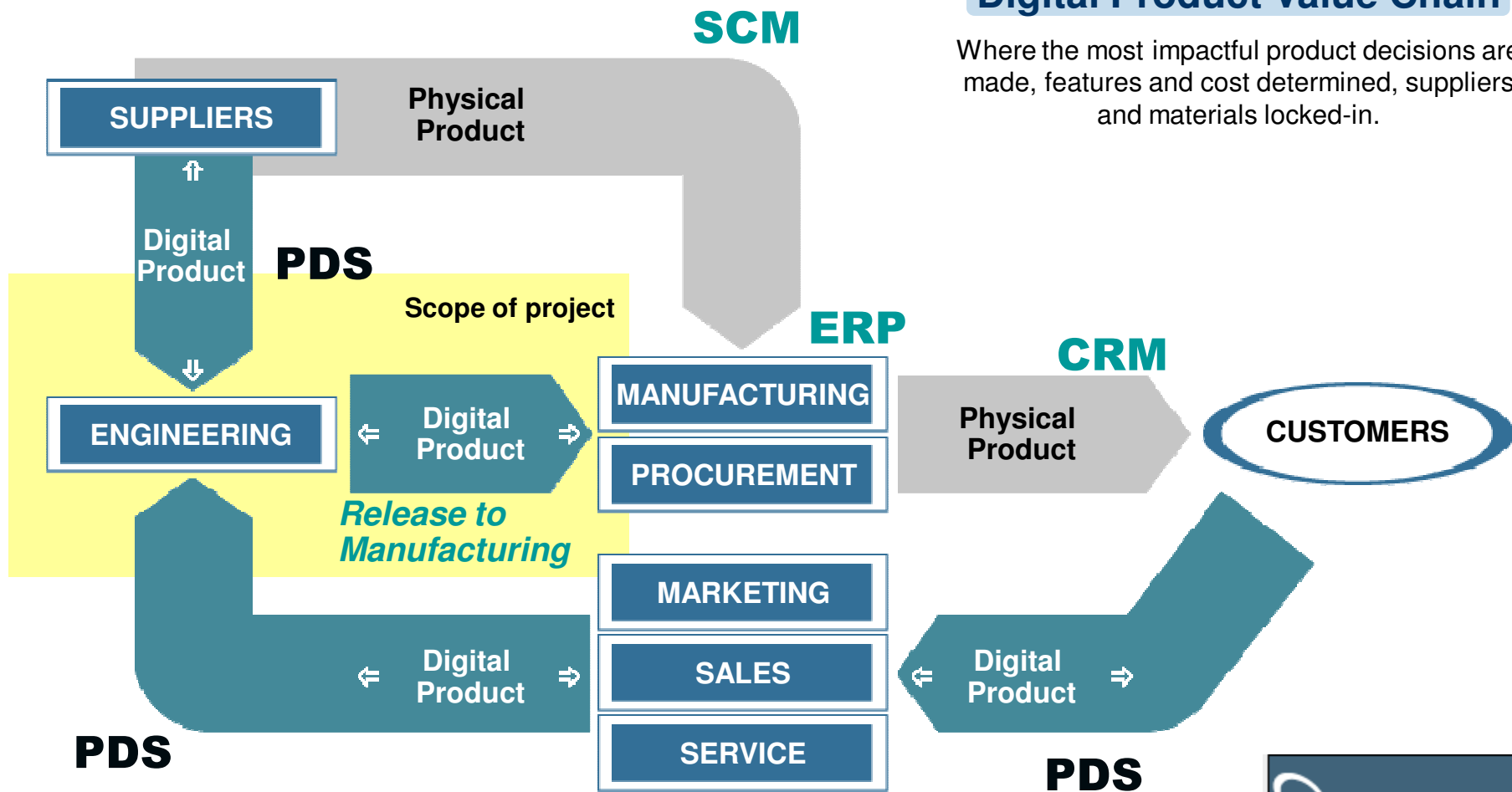

Product Development Today

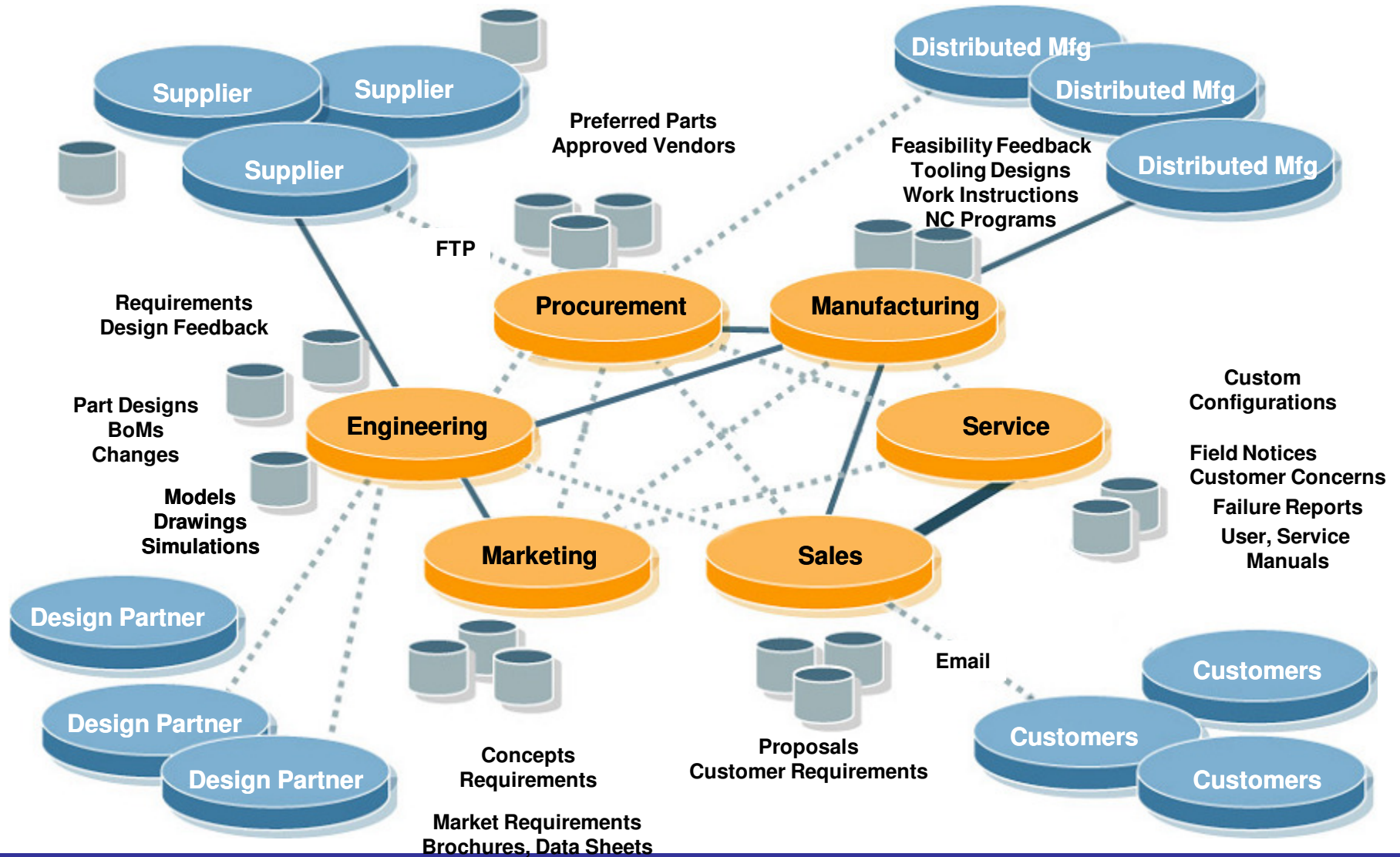

Optimized Product Development System

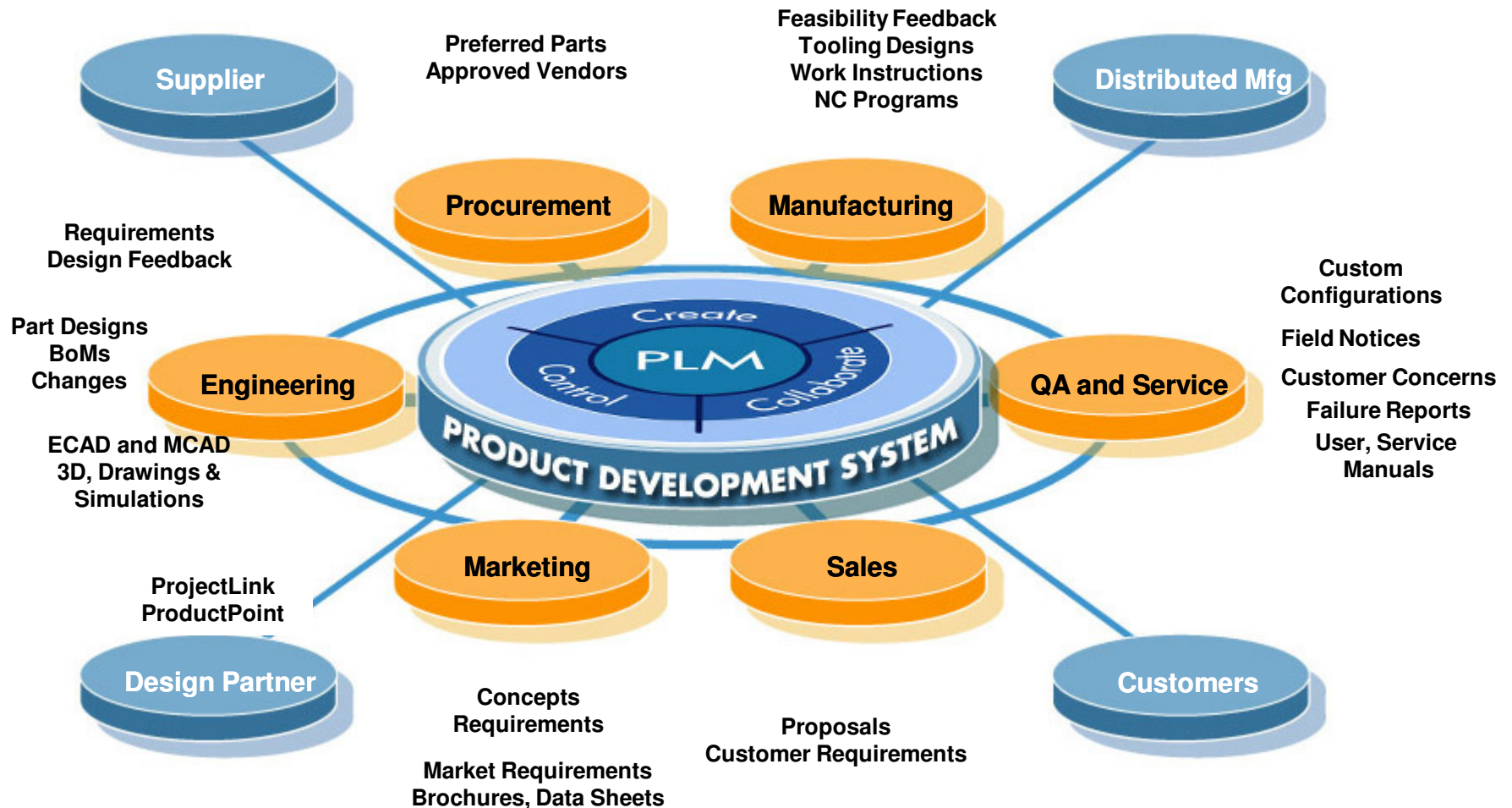

Optimized Engineering Application Focused

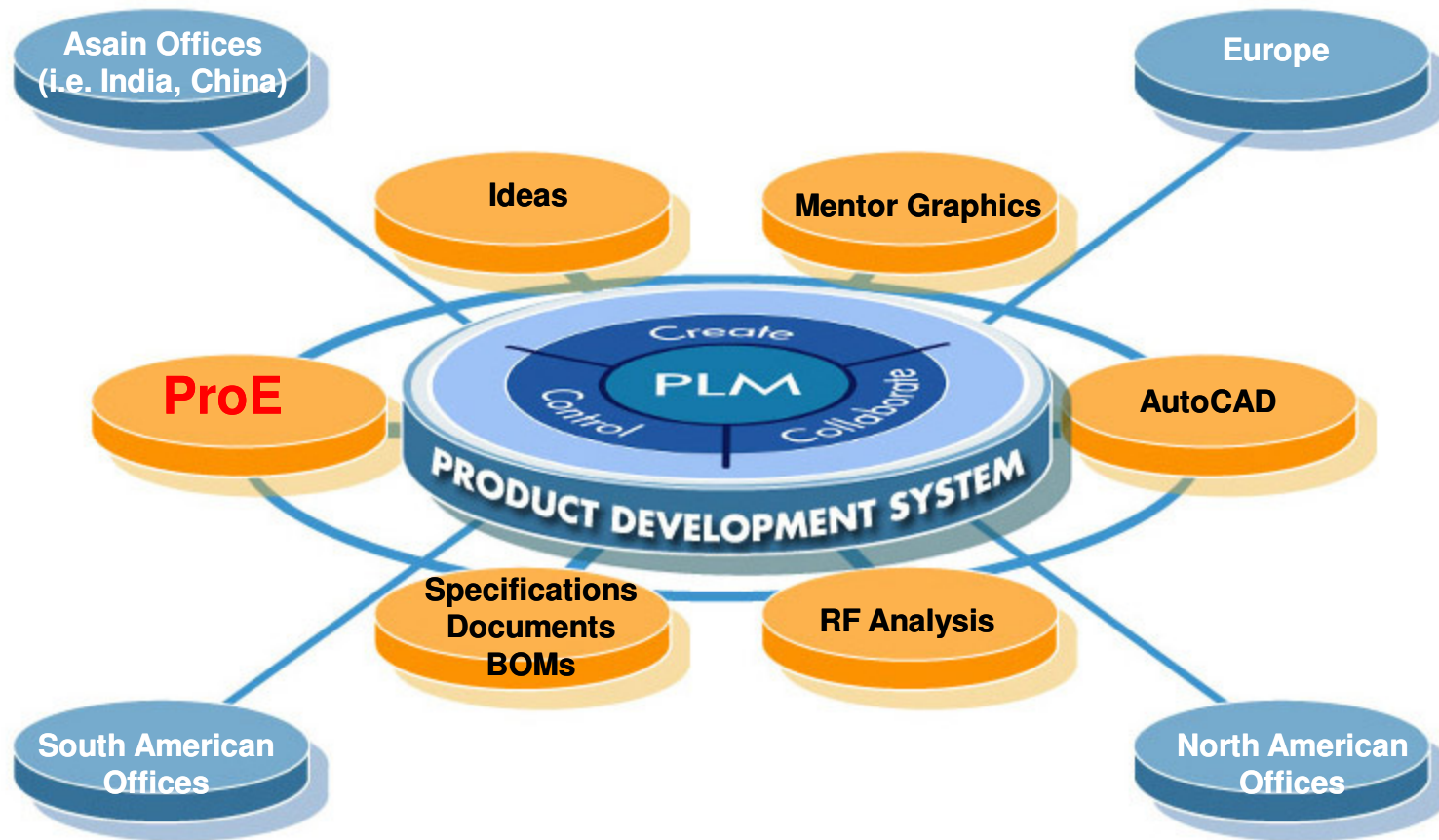

Standard Global Business Practice

- **In an organization, the number is unique to identify a part.**
- **Types Documents that describe the part can be numbered identical to the part number.**
- **Documents of the same type have a unique number.**

Duplication between Project and PDMLink

- Duplication is due to the fact that ProjectLink and PDMLink started and can be sold as separate systems. The duplication was allowed to make migration of the solutions easier. But it does not follow the business enterprise solution.
- All Com Dev IP Part information is properly numbered and checked into the common PDMLink. There cannot be duplication of Part Numbers.
- ProjectLink is used as a collaboration sharing portal for external ODMs for intellectual property. ODMs can create designs to be approved and checked back into "SEND TO PDM" the common PDMLink.
- Depending on CAD authoring application and author, CAD files are numbered according to the Part Number
- With various CAD authoring applications of Ideas, ProE and Mentor, the files are numbered according to the Part Number
- There can only be one unique number per CAD/DOC type that corresponds to COMDEV Part.

Step 1 – User Down Time

- Applying this solution must take place on mirrored development, test and then production in that order when users are notified not to use the system.
- Prior to implementing on Production, it is advised to perform rigorous testing on development and test after implementing the solution

Step 2a – Finding Duplicates

- **Duplication between Project and PDMLink allowed for WTParts, WTDocuments and EPMDocuments**
 - **Allowed to create, modify, approve and revise duplicate items in either ProjectLink and PDMLink**

```
SQL> SELECT WTKEY FROM WTPARTMASTERKEY GROUP BY WTKEY HAVING COUNT(*) > 1;  
SQL> SELECT WTKEY FROM WTDOCUMENTMASTERKEY GROUP BY WTKEY HAVING COUNT(*) > 1;  
SQL> SELECT WTKEY FROM EPMDOCUMENTMASTERKEY GROUP BY WTKEY HAVING COUNT(*) > 1;
```

or

```
SQL> SELECT WTPARTNUMBER FROM WTPARTMASTER GROUP BY WTPARTNUMBER HAVING COUNT(*) > 1;  
SQL> SELECT WTDOCUMENTNUMBER FROM WTDOCUMENTMASTER GROUP BY WTDOCUMENTNUMBER HAVING  
COUNT(*) > 1;  
SQL> SELECT DOCUMENTNUMBER FROM EPMDOCUMENTMASTER GROUP BY DOCUMENTNUMBER HAVING  
COUNT(*) > 1;
```

Step 2b – Finding Duplicates via Oracle

```
SELECT "EPMDOCUMENTMASTER"."CADNAME" as "CADNAME", "EPMDOCUMENTMASTER"."AUTHORINGAPPLICATION" as "AUTHORINGAPPLICATION",  
"EPMDOCUMENTMASTER"."CLASSNAMEKEYCONTAINERREFEREN" as "CLASSNAMEKEYCONTAINERREFEREN",  
"EPMDOCUMENTMASTER"."IDA3CONTAINERREFERENCE" as "IDA3CONTAINERREFERENCE", "EPMDOCUMENTMASTER"."DEFAULTUNIT" as "DEFAULTUNIT",  
"EPMDOCUMENTMASTER"."DOCSUBTYPE" as "DOCSUBTYPE", "EPMDOCUMENTMASTER"."DOCTYPE" as "DOCTYPE", "EPMDOCUMENTMASTER"."NAME" as "NAME",  
"EPMDOCUMENTMASTER"."DOCUMENTNUMBER" as "DOCUMENTNUMBER", "EPMDOCUMENTMASTER"."CLASSNAMEKEYA6" as "CLASSNAMEKEYA6",  
"EPMDOCUMENTMASTER"."IDA3A6" as "IDA3A6", "EPMDOCUMENTMASTER"."CLASSNAMEKEYORGANIZATIONREFE" as "CLASSNAMEKEYORGANIZATIONREFE",  
"EPMDOCUMENTMASTER"."IDA3ORGANIZATIONREFERENCE" as "IDA3ORGANIZATIONREFERENCE", "EPMDOCUMENTMASTER"."OWNERAPPLICATION" as  
"OWNERAPPLICATION", "EPMDOCUMENTMASTER"."SERIES" as "SERIES", "EPMDOCUMENTMASTER"."CREATESTAMPA2" as "CREATESTAMPA2",  
"EPMDOCUMENTMASTER"."MARKFORDELETEA2" as "MARKFORDELETEA2", "EPMDOCUMENTMASTER"."MODIFYSTAMPA2" as "MODIFYSTAMPA2",  
"EPMDOCUMENTMASTER"."CLASSNAMEA2A2" as "CLASSNAMEA2A2", "EPMDOCUMENTMASTER"."IDA2A2" as  
"IDA2A2", "EPMDOCUMENTMASTER"."UPDATECOUNTA2" as "UPDATECOUNTA2", "EPMDOCUMENTMASTER"."UPDATESTAMPA2" as "UPDATESTAMPA2",  
"EPMDOCUMENTMASTER"."BRANCHIDA2TYPEDEFINITIONREFE" as "BRANCHIDA2TYPEDEFINITIONREFE", "EPMDOCUMENTMASTER"."IDA2TYPEDEFINITIONREFERENCE"  
as "IDA2TYPEDEFINITIONREFERENCE" FROM "EPMDOCUMENTMASTER" WHERE ( "DOCUMENTNUMBER" = 'ENTER NUMBER HERE' )
```

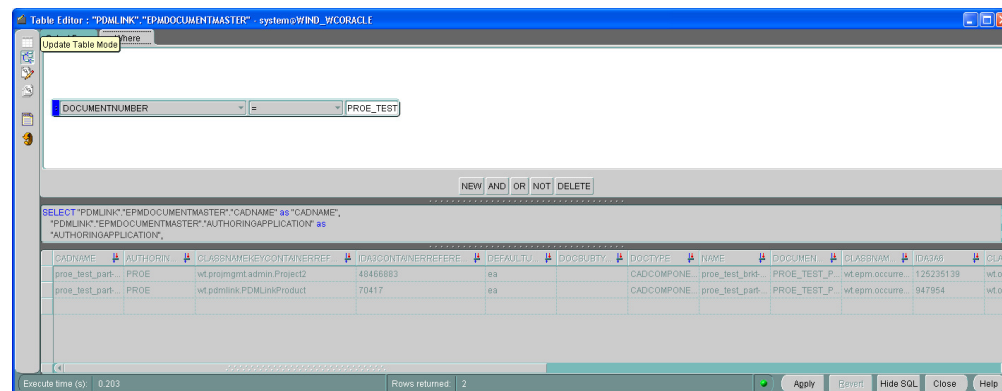

The screenshot shows a 'Table Editor' window for the 'EPMDOCUMENTMASTER' table. The 'Where' clause is set to 'DOCUMENTNUMBER = PROE_TEST'. The SQL query is: `SELECT "PDMLINK"."EPMDOCUMENTMASTER"."CADNAME" as "CADNAME", "PDMLINK"."EPMDOCUMENTMASTER"."AUTHORINGAPPLICATION" as "AUTHORINGAPPLICATION", "AUTHORINGAPPLICATION",`. The results table has 12 columns: CADNAME, AUTHORIN, CLASSNAMEKEYCONTAINERREF, IDA3CONTAINERREFERE, DEFAULTU, DOCSUBTY, DOCTYPE, NAME, DOCUMENT, CLASSNAM, IDA3A6, and CLAS. Two rows are returned, both with 'PROE' as the AUTHORIN and 'wt.pmlink.PDMLinkProduct' as the CLASSNAMEKEYCONTAINERREF.

CADNAME	AUTHORIN	CLASSNAMEKEYCONTAINERREF	IDA3CONTAINERREFERE	DEFAULTU	DOCSUBTY	DOCTYPE	NAME	DOCUMENT	CLASSNAM	IDA3A6	CLAS
proe_test_part...	PROE	wt.projmgmt.admin.Project2	48468883	ea		CADCOMPONE	proe_test_bri-	PROE_TEST_P	wt.epm.occure	125235138	wt.org
proe_test_part...	PROE	wt.pmlink.PDMLinkProduct	70417	ea		CADCOMPONE	proe_test_part-	PROE_TEST_P	wt.epm.occure	947954	wt.org

Step 3a – Renumbering Duplicates

- A decision is made to renumber the object in either ProjectLink or PDMLink using UI of Windchill
- At site level using Windchill Search, search for the number and select Rename in the Actions link.
- Enter a new number and filename then select OK
 - Most cases, I would renumber and change the filename of the ProjectLink objects to:
Number: 1234567 → 1234567_projectname
Filename: 1234567.prt → 1234567_projectname.prt
- Rerun the SQLs in step 1 to confirm that you did not renumber or change the file name that exist in another project.

Step 3b – Renumbering Duplicates in Oracle

- There are cases where the duplicate is in a Project Workspace. Thus using the search in Windchil will only show one result. In Oracle you can find the duplicate record in the EPMDOCUMENTMASTER table

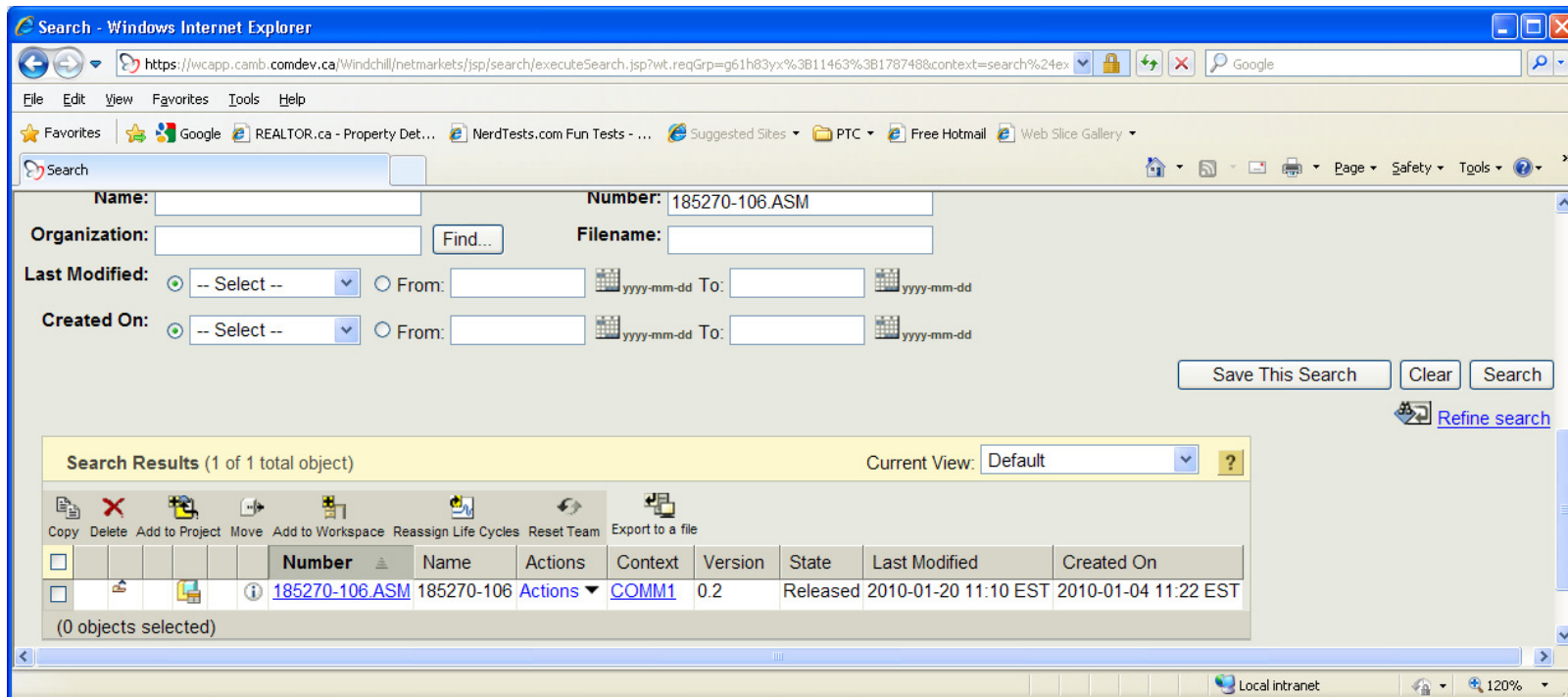

Step 3b – Finding Duplicates Context in Oracle

- The “EPMDOCUMENTMASTER”.”IDA3CONTAINERREFERENCE” is the reference value of PROJECT2.IDA2A2, PDMLINKPRODUCT.IDA2A2 and WTLIBRARY.IDA2A2

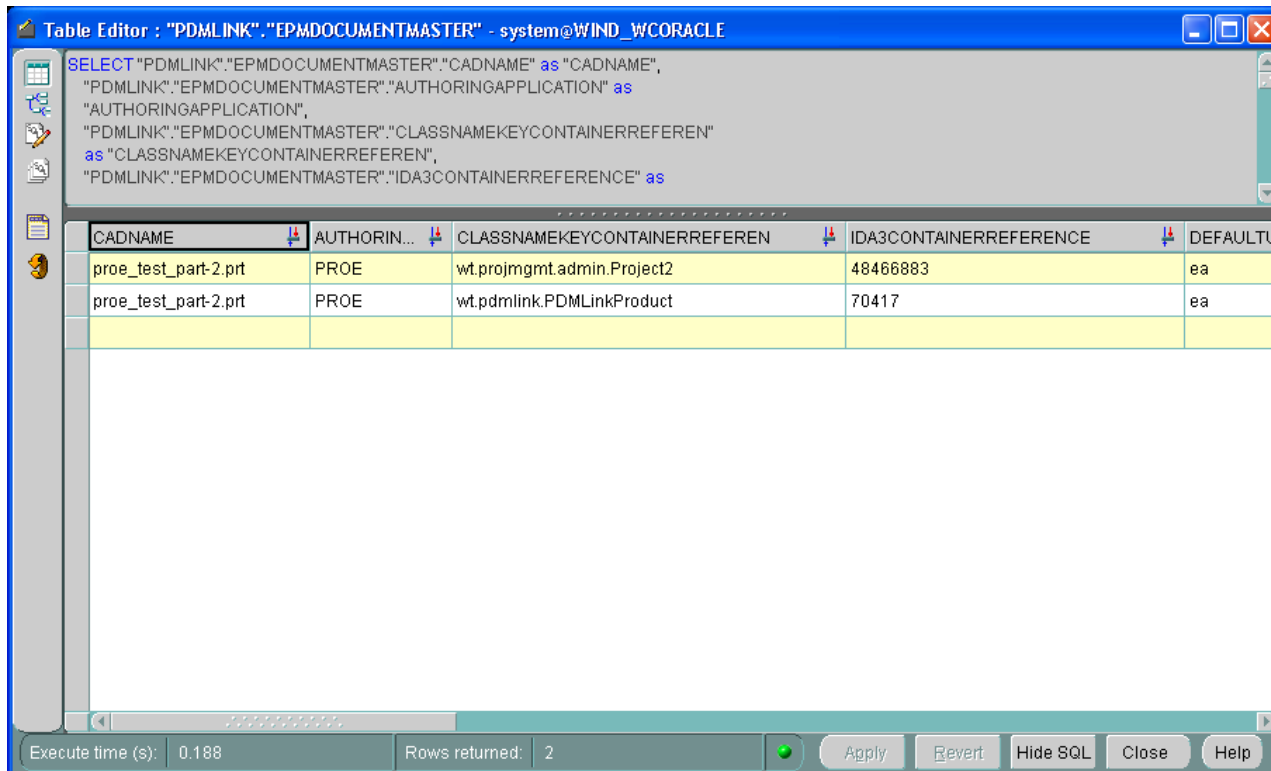

Table Editor : "PDMLINK"."EPMDOCUMENTMASTER" - system@WIND_WCORACLE

```
SELECT "PDMLINK"."EPMDOCUMENTMASTER"."CADNAME" as "CADNAME",  
"PDMLINK"."EPMDOCUMENTMASTER"."AUTHORINGAPPLICATION" as  
"AUTHORINGAPPLICATION",  
"PDMLINK"."EPMDOCUMENTMASTER"."CLASSNAMEKEYCONTAINERREFEREN"  
as "CLASSNAMEKEYCONTAINERREFEREN",  
"PDMLINK"."EPMDOCUMENTMASTER"."IDA3CONTAINERREFERENCE" as
```

CADNAME	AUTHORIN...	CLASSNAMEKEYCONTAINERREFEREN	IDA3CONTAINERREFERENCE	DEFAULTU
proe_test_part-2.prt	PROE	wt.projmgmt.admin.Project2	48466883	ea
proe_test_part-2.prt	PROE	wt.pdmlink.PDMLinkProduct	70417	ea

Execute time (s): 0.188 Rows returned: 2 Apply Revert Hide SQL Close Help

Step 3c – Finding the Duplicates Context in Oracle

- In this case, a search was performed in Project2 table:

```
SELECT "PROJECT2"."CLASSNAMEKEYA2CONTAINERINFO" as "CLASSNAMEKEYA2CONTAINERINFO", "PROJECT2"."IDA3A2CONTAINERINFO" as  
"IDA3A2CONTAINERINFO", "PROJECT2"."NAMECONTAINERINFO" as "NAMECONTAINERINFO", "PROJECT2"."CLASSNAMEKEYCONTAINERREFEREN" as  
"CLASSNAMEKEYCONTAINERREFEREN", "PROJECT2"."IDA3CONTAINERREFERENCE" as "IDA3CONTAINERREFERENCE",  
"PROJECT2"."CLASSNAMEKEYORGANIZATIONREFE" as "CLASSNAMEKEYORGANIZATIONREFE", "PROJECT2"."IDA3ORGANIZATIONREFERENCE" as  
"IDA3ORGANIZATIONREFERENCE", "PROJECT2"."PROJECTNUMBER" as "PROJECTNUMBER", "PROJECT2"."CLASSNAMEKEYA7" as "CLASSNAMEKEYA7",  
"PROJECT2"."IDA3A7" as "IDA3A7", "PROJECT2"."CLASSNAMEA2A2" as "CLASSNAMEA2A2", "PROJECT2"."IDA2A2" as "IDA2A2" FROM "PROJECT2"  
WHERE ( "IDA2A2" = '48466883' )
```

The screenshot shows the Oracle Table Editor interface for the 'PROJECT2' table. The search criteria are set to 'IDA2A2 = 48466883'. The SQL query is displayed in the editor, and the results table shows one row with IDA2A2 value 48466886.

CLASSNAM...	IDA3A2CON...	NAMECONT...	CLASSNAM...	IDA3CONTA...	CLASSNAM...	IDA3ORGA...	PROJECTN...	CLASSNAM...	IDA3A7
wt.org.WTGroup	48466886	India Project	wt.inf.container...	5190	wt.org.WTOrga...	837	000023	wt.org.WTUser	7977

Step 3d – Renumbering Both EPMDOCUMENTMASTER AND EPMDOCUMENTMASTERKEY Duplicates in Oracle

- the objects EPMDOCUMENTMASTERKEY.WTKEY, EPMDOCUMENTMASTER.CADNAME and EPMDOCUMENTMASTER.DOCUMENTNUMBER were reset to *_india*:

```
SELECT WTKEY FROM EPMDOCUMENTMASTERKEY GROUP BY WTKEY HAVING COUNT(*) > 1;
```

```
SELECT "PDMLINK"."EPMDOCUMENTMASTERKEY"."WTKEY" as "WTKEY",  
"PDMLINK"."EPMDOCUMENTMASTERKEY"."CLASSNAMEKEYA4" as "CLASSNAMEKEYA4",  
"PDMLINK"."EPMDOCUMENTMASTERKEY"."IDA3A4" as "IDA3A4"  
from "PDMLINK"."EPMDOCUMENTMASTERKEY" where ("WTKEY"='185439-GSE.ASM');
```

```
SELECT "PDMLINK"."EPMDOCUMENTMASTER"."IDA2A2" as "IDA2A2",  
"PDMLINK"."EPMDOCUMENTMASTER"."CADNAME" as "CADNAME",  
"PDMLINK"."EPMDOCUMENTMASTER"."DOCUMENTNUMBER" as "DOCUMENTNUMBER",  
"PDMLINK"."EPMDOCUMENTMASTER"."CLASSNAMEKEYCONTAINERREFEREN" as "CLASSNAMEKEYCONTAINERREFEREN",  
"PDMLINK"."EPMDOCUMENTMASTER"."IDA3CONTAINERREFERENCE" as "IDA3CONTAINERREFERENCE",  
"PDMLINK"."EPMDOCUMENTMASTER"."AUTHORINGAPPLICATION" as "AUTHORINGAPPLICATION"  
from "PDMLINK"."EPMDOCUMENTMASTER" where ("IDA2A2"='124636760');
```

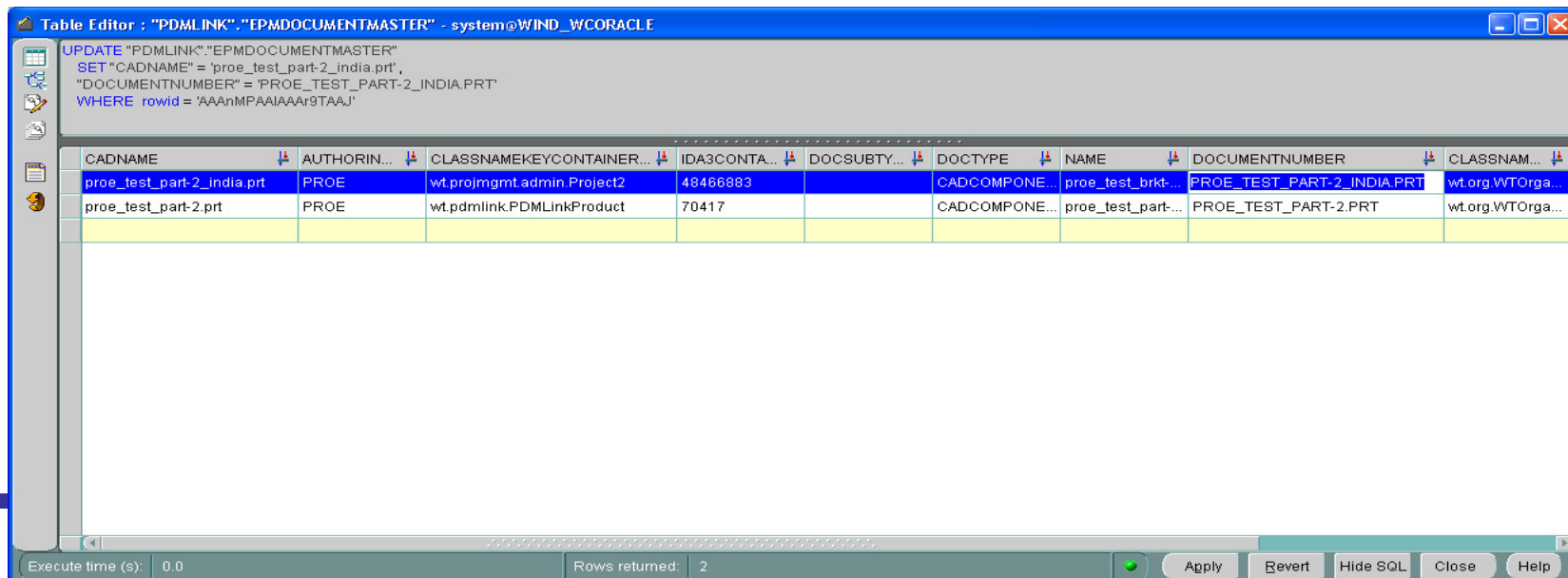

The screenshot shows the Oracle Table Editor interface. The title bar reads "Table Editor : 'PDMLINK'. 'EPMDOCUMENTMASTER' - system@WIND_WCORACLE". The main window displays an SQL UPDATE statement:

```
UPDATE "PDMLINK"."EPMDOCUMENTMASTER"  
SET "CADNAME" = 'proe_test_part-2_india.prt',  
"DOCUMENTNUMBER" = 'PROE_TEST_PART-2_INDIA.PRT'  
WHERE rowid = 'AAAnMPAAIAAAr9TAAJ'
```

Below the SQL editor is a table with the following columns and data:

CADNAME	AUTHORIN...	CLASSNAMEKEYCONTAINER...	IDA3CONTA...	DOCSUBTY...	DOCTYPE	NAME	DOCUMENTNUMBER	CLASSNAM...
proe_test_part-2_india.prt	PROE	wt.projmgmt.admin.Project2	48466883		CADCOMPONE...	proe_test_brkt...	PROE_TEST_PART-2_INDIA.PRT	wt.org.WTOrga...
proe_test_part-2.prt	PROE	wt.pdmlink.PDMLinkProduct	70417		CADCOMPONE...	proe_test_part...	PROE_TEST_PART-2.PRT	wt.org.WTOrga...

At the bottom of the window, the status bar shows "Execute time (s): 0.0", "Rows returned: 2", and buttons for "Apply", "Revert", "Hide SQL", "Close", and "Help".

Step 4 – Adding More Doctypes to Synchronize with File Extensions

- Depending on your CAD tool, you may need to add more doctypes

Step 5 – Current Oracle Unique Indexes in Windchill

- **Currently uniqueness is based on**

- **For WTPART**

- WTPARTMASTERKEY\$UNIQUE ON WTPARTMASTERKEY Table

- WTKEY, IDA3ORAGANIZATIONREFERENCE, IDA3NAMESPACEREFERENCE

- **For WTDOCUMENT**

- WTDOCUMENTMASTERKEY\$UNIQUE ON WTDOCUMENTMASTERKEY Table

- WTKEY, IDA3ORAGANIZATIONREFERENCE, IDA3NAMESPACEREFERENCE

- **For EPMDOCUMENT**

- EPMDOCUMENTMASTERKEY\$UNIQUE ON EPMDOCUMENTMASTERKEY Table

- WTKEY, IDA3ORAGANIZATIONREFERENCE, IDA3NAMESPACEREFERENCE

Step 5 – New Oracle Unique Indexes to Enforce Uniqueness in PLM

- In SQLPLUS logged in as the Windchill oracle user, run the following command to drop and recreate the new unique indexes*

```
SQL> drop index WTPartMasterKey$UNIQUE;
```

```
SQL> drop index WTDocumentMasterKey$UNIQUE;
```

```
SQL> drop index EPMDocumentMasterKey$UNIQUE;
```

```
SQL> CREATE UNIQUE INDEX WTPartMasterKey$UNIQUE ON WTPartMasterKey(wtkey,idA3organizationReference)  
TABLESPACE INDX STORAGE ( INITIAL 20k NEXT 20k PCTINCREASE 0 );
```

```
SQL> CREATE UNIQUE INDEX WTDocumentMasterKey$UNIQUE ON  
WTDocumentMasterKey(wtkey,idA3organizationReference) TABLESPACE INDX STORAGE ( INITIAL 20k NEXT 20k  
PCTINCREASE 0 );
```

```
Or SQL> CREATE UNIQUE INDEX WTDocumentMaster$UNIQUE ON  
WTDocumentMaster(WTdocumentnumber,doctype,idA3organizationReference) TABLESPACE INDX STORAGE (   
INITIAL 20k NEXT 20k PCTINCREASE 0 );
```

```
SQL> CREATE UNIQUE INDEX EPMDocumentMaster$UNIQUE ON  
EPMDocumentMaster(documentnumber,doctype,authoringapplication,idA3organizationReference) TABLESPACE INDX  
STORAGE ( INITIAL 20k NEXT 20k PCTINCREASE 0 );
```

```
SQL> CREATE UNIQUE INDEX EPMDocumentMasterFile$UNIQUE ON  
EPMDocumentMaster(cadname,authoringapplication,idA3organizationReference) TABLESPACE INDX STORAGE ( INITIAL  
20k NEXT 20k PCTINCREASE 0 );
```

Step 6 – Updating Site Preferences

- Documents

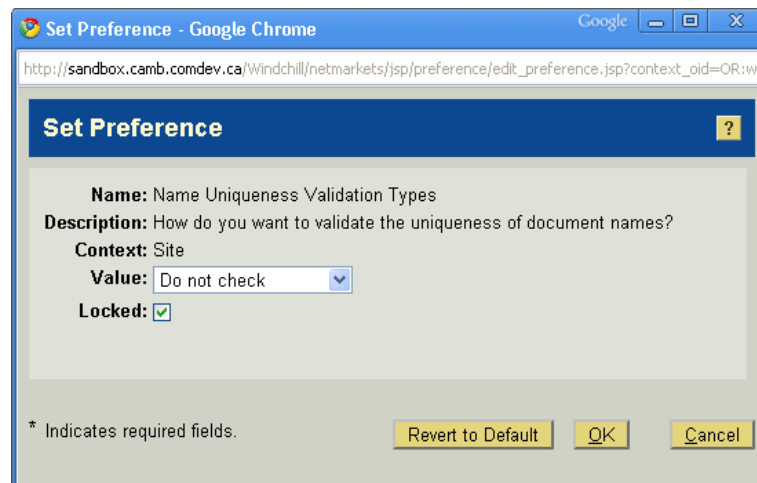
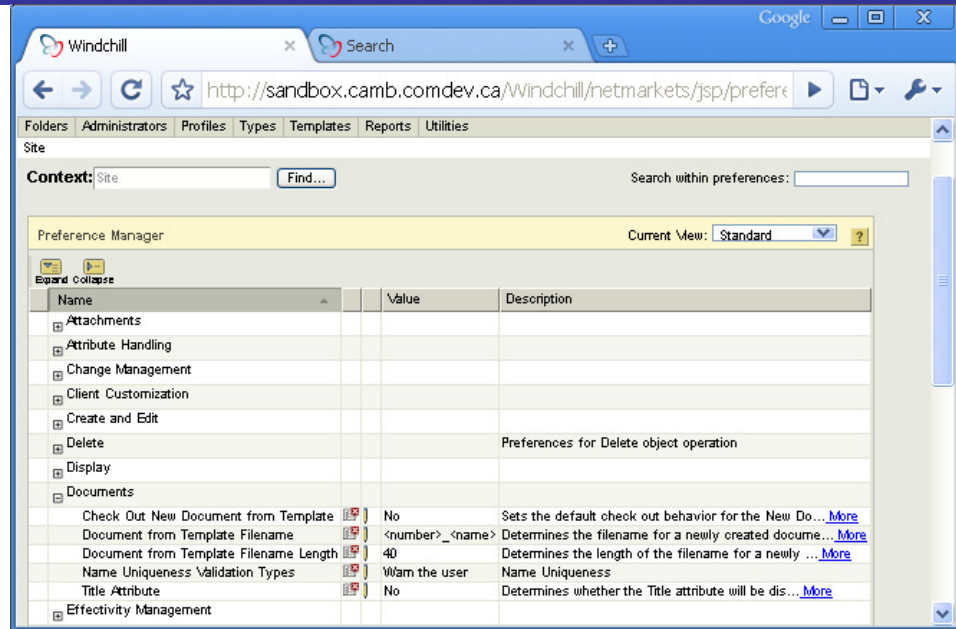

Step 6 – Updating Site Preferences - Windchill Workgroup Manager

The top-left screenshot displays a table of preferences:

Category	Name	Description	More
Visualization			
Windchill Workgroup Manager	Windchill Workgroup Manager		
Client	Client side Windchill Workgroup Manager preference...		More
Client	Upload Drop Name File Extension	Yes	More
	Upload Drop Number File Extension	Yes	More
	Upload After Native Save	No	More
	Upload CAD Document and Attachment Filter	No	More
Server	Use Explicit Mapping for Designated Parameter Crea...	No	More
	Is Model Name Unique	No	More
Server	Synchronize CAD Model Name with CAD Doc Number	Yes	More
	Preferences for Cad Doc Property Page		More
	Remove from Workspace		More
	Rename		More

The top-right screenshot shows the 'Set Preference' dialog for 'Upload Drop Name File Extension' with the following details:

- Name: Upload Drop Name File Extension
- Description: Upload Drop Name File Extension
- Client: Windchill
- Context: Site
- * Value: Undefined, Yes, No
- Locked:

The bottom-left screenshot shows the 'Set Preference' dialog for 'Is Model Name Unique' with the following details:

- Name: Is Model Name Unique
- Description: Specifies if CAD model name is unique for new CAD Document. The default is true.
- Context: Site
- * Value: Undefined, Yes, No
- Locked:

The bottom-middle screenshot shows the 'Set Preference' dialog for 'Upload Drop Number File Extension' with the following details:

- Name: Upload Drop Number File Extension
- Description: Upload Drop Number File Extension
- Client: Windchill
- Context: Site
- * Value: Undefined, Yes, No
- Locked:

The bottom-right screenshot shows the 'Set Preference' dialog for 'Synchronize CAD Model Name with CAD Doc Number' with the following details:

- Name: Synchronize CAD Model Name with CAD Doc Number
- Description: Specifies if the CAD model name is synchronized with the CAD document number in the New CAD Document user interface. When set to true, synchronizes the CAD model name with the CAD document number in the New CAD Document user interface. This synchronization is not applicable when auto numbering is in effect. The default is false.
- Context: Site
- * Value: Undefined, Yes, No
- Locked:

Step 7 – Updating Table Views in Windchill Workgroup Manager

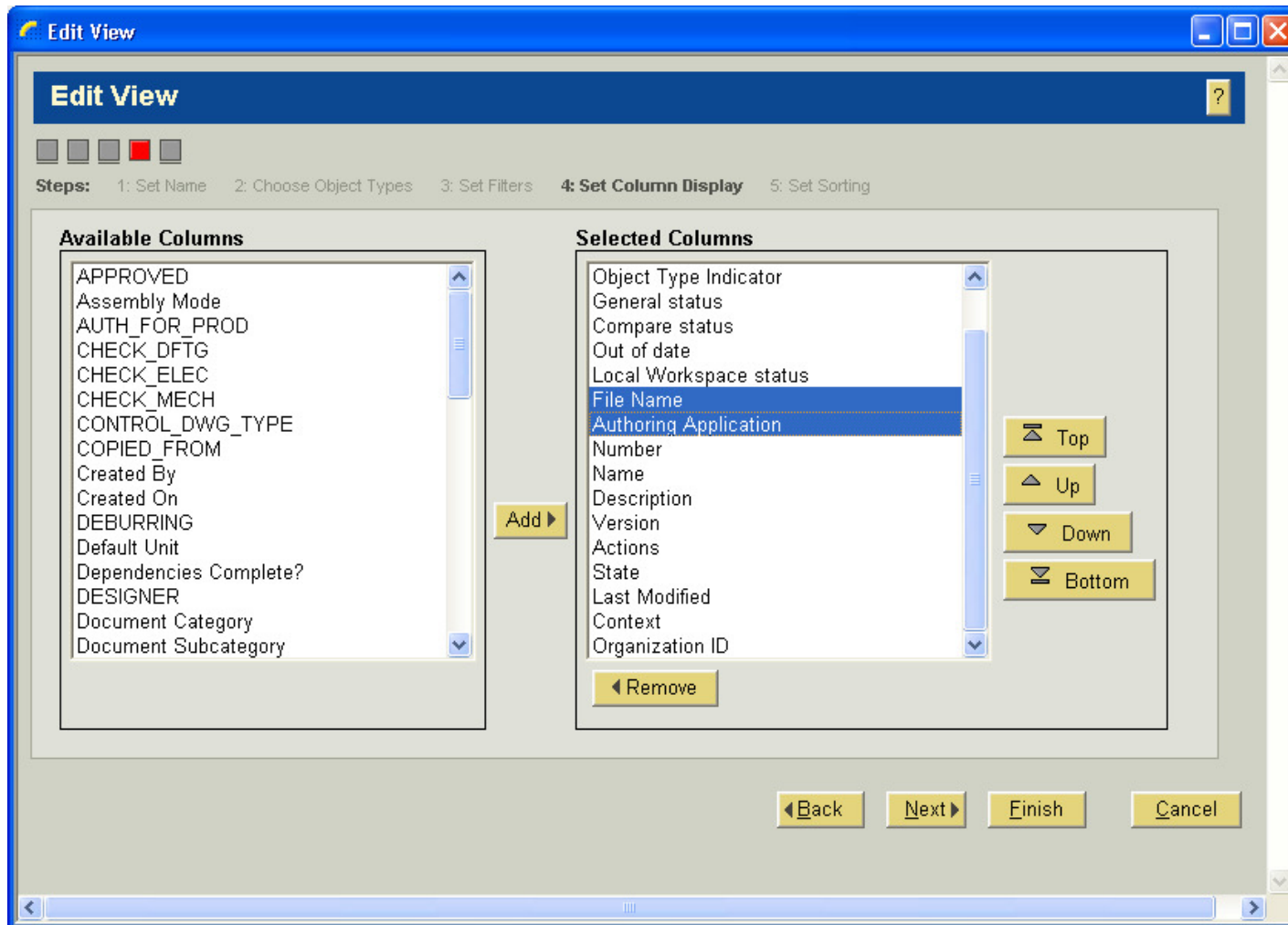

Step 7 – Updating Table Folder Views in Contexts (Products, Projects & Libraries)

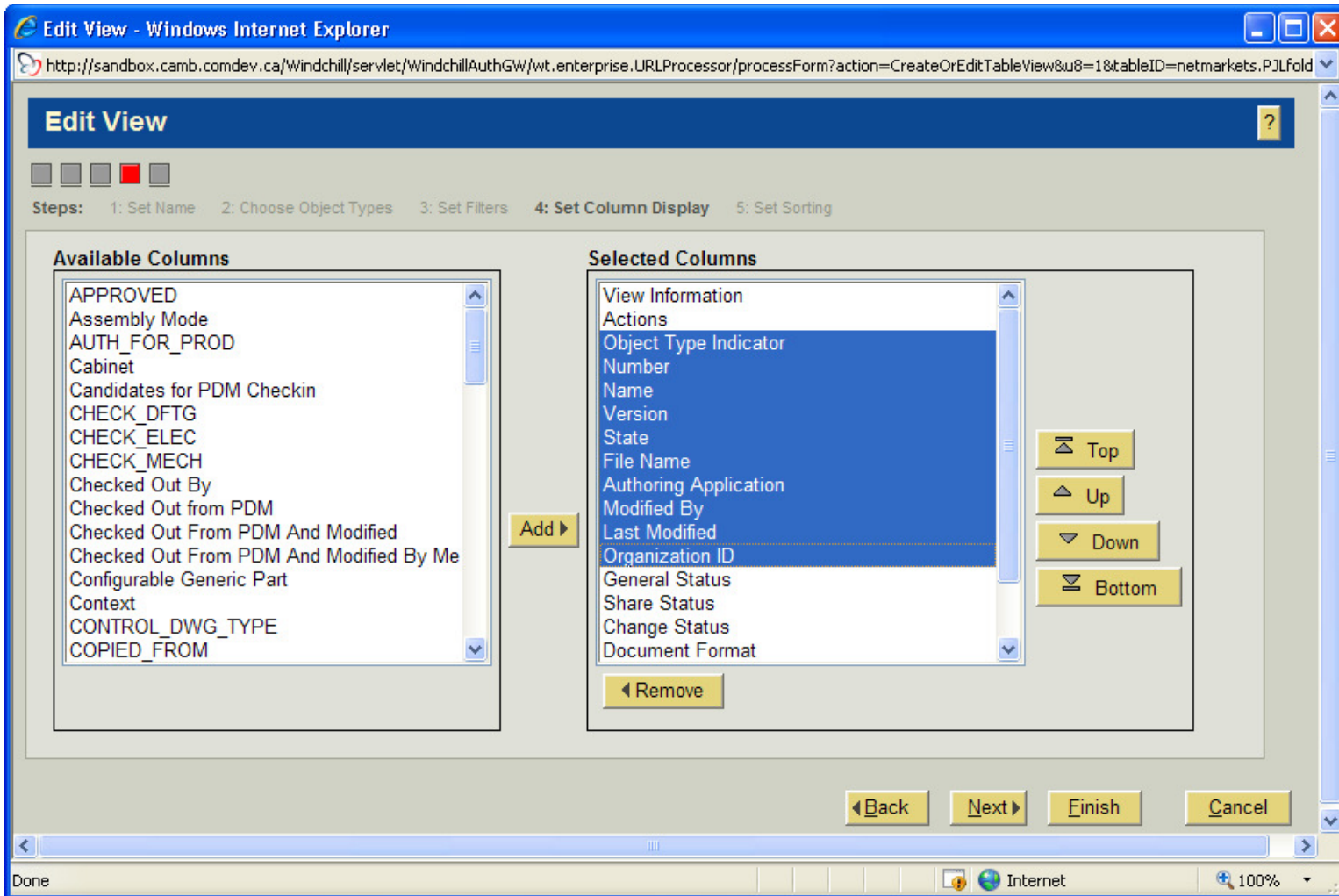

Step 8 – Additional Steps. Must do if this solution is applied prior to Upgrade

- In Pro/E WGM, it performs file name uniqueness in a API which is not necessary and redundant because it is already performed at the database level. This must be removed or disabled via PTC support or customization.
- ***During upgrades, prior to Adding Constraints stage in the upgrade, the \$WT_HOME/Upgrade/Upgrade/UpgradePhases/AddConstraints/UniqueWork.sql must be modified to accommodate the new unique indexes.**
- CREATE UNIQUE INDEX EPMDOCUMENTMASTERKEY\$UNIQ0 ON EPMDocumentMasterKey(wtkey,idA3organizationReference,idA3namespaceReference) TABLESPACE INDX STORAGE (INITIAL 20k NEXT 20k PCTINCREASE 0)
- CREATE UNIQUE INDEX WTDOCUMENTMASTERKEY\$UNIQ0 ON WTDocumentMasterKey(wtkey,idA3organizationReference,idA3namespaceReference) TABLESPACE INDX STORAGE (INITIAL 20k NEXT 20k PCTINCREASE 0)
- CREATE UNIQUE INDEX WTPARTMASTERKEY\$UNIQ0 ON WTPartMasterKey(wtkey,idA3organizationReference,idA3namespaceReference) TABLESPACE INDX STORAGE (INITIAL 1m NEXT 1m PCTINCREASE 0)
- **Changed to:**
- CREATE UNIQUE INDEX EPMDocumentMaster\$UNIQUE ON EPMDocumentMaster(documentnumber,doctype,authoringapplication,idA3organizationReference) TABLESPACE INDX STORAGE (INITIAL 20k NEXT 20k PCTINCREASE 0);
- /
- CREATE UNIQUE INDEX EPMDocumentMasterFile\$UNIQUE ON EPMDocumentMaster(cadname,authoringapplication,idA3organizationReference) TABLESPACE INDX STORAGE (INITIAL 20k NEXT 20k PCTINCREASE 0);
- CREATE UNIQUE INDEX WTDocumentMasterKey\$UNIQUE ON WTDocumentMasterKey(wtkey,idA3organizationReference) TABLESPACE INDX STORAGE (INITIAL 20k NEXT 20k PCTINCREASE 0);
- CREATE UNIQUE INDEX WTPartMasterKey\$UNIQUE ON WTPartMasterKey(wtkey,idA3organizationReference) TABLESPACE INDX STORAGE (INITIAL 20k NEXT 20k PCTINCREASE 0);

Result of this Solution

- WTPart
 - Only 1 unique WTPart can exist per organization
- WTDocument
 - Only 1 unique WTDocument can exist per organization
- EPMDocuments
 - Are uniquely managed according to number, type, authoring application and organization
 - EPM file names are also uniquely managed according to filenames, authoring application and organization (**i.e. Pro/INTRALINK behavior**)
- Thus:
 - Auto Association of CAD to Part will be based on synchronizing CAD and WTPart number only. If there is no respective Part number, there will not be an auto creation of Parts
 - Number generation is manual for WTDocuments and EPMDocuments if there is a requirement to synchronize WTPart number

Result of this Solution – Workspace View

The screenshot shows the Windchill workspace view for a workspace named "Workspace on TestOnly". The status is "Running". The object list contains 4 objects:

File Name	Generic	Instance	Authoring Application	Number	Name	Description	Version	Actions	State	Last Modified	Context	Organiza
123456789.asm	False	False	Pro/ENGINEER	123456789	assembly unique		P0.1	[Info] [Refresh] [Down Arrow]	In Work	2009-11-13 13:17 EDT	TestOnly	Comdev
123456789.dwg	False	False	Pro/ENGINEER	123456789	drawing unique		P0.1	[Info] [Refresh] [Down Arrow]	In Work	2009-11-13 13:09 EDT	TestOnly	Comdev
123456789.sec	False	False	Pro/ENGINEER	123456789	sketch unique		P0.1	[Info] [Refresh] [Down Arrow]	In Work	2009-11-13 12:02 EDT	TestOnly	Comdev
123456789.prt	False	False	Pro/ENGINEER	123456789	unique component		P0.1	[Info] [Refresh] [Down Arrow]	In Work	2009-11-13 13:07 EDT	TestOnly	Comdev

(0 objects selected)

Powered by Windchill® About Windchill Copyright © 2007 Parametric Technology Corporation. All Rights Reserved.

Result of this Solution – Context Folder View

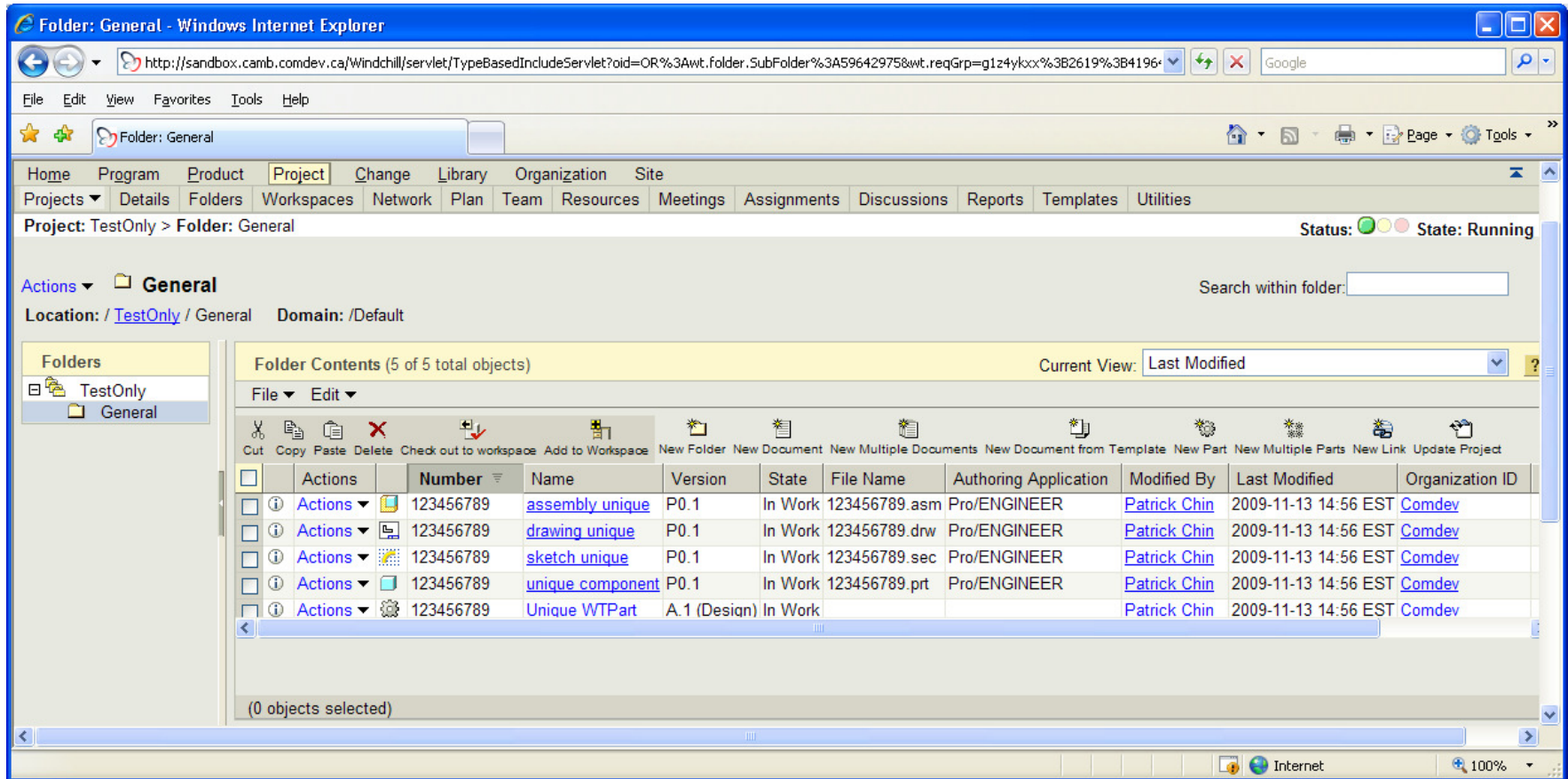

Pro/INTRALINK Migrations

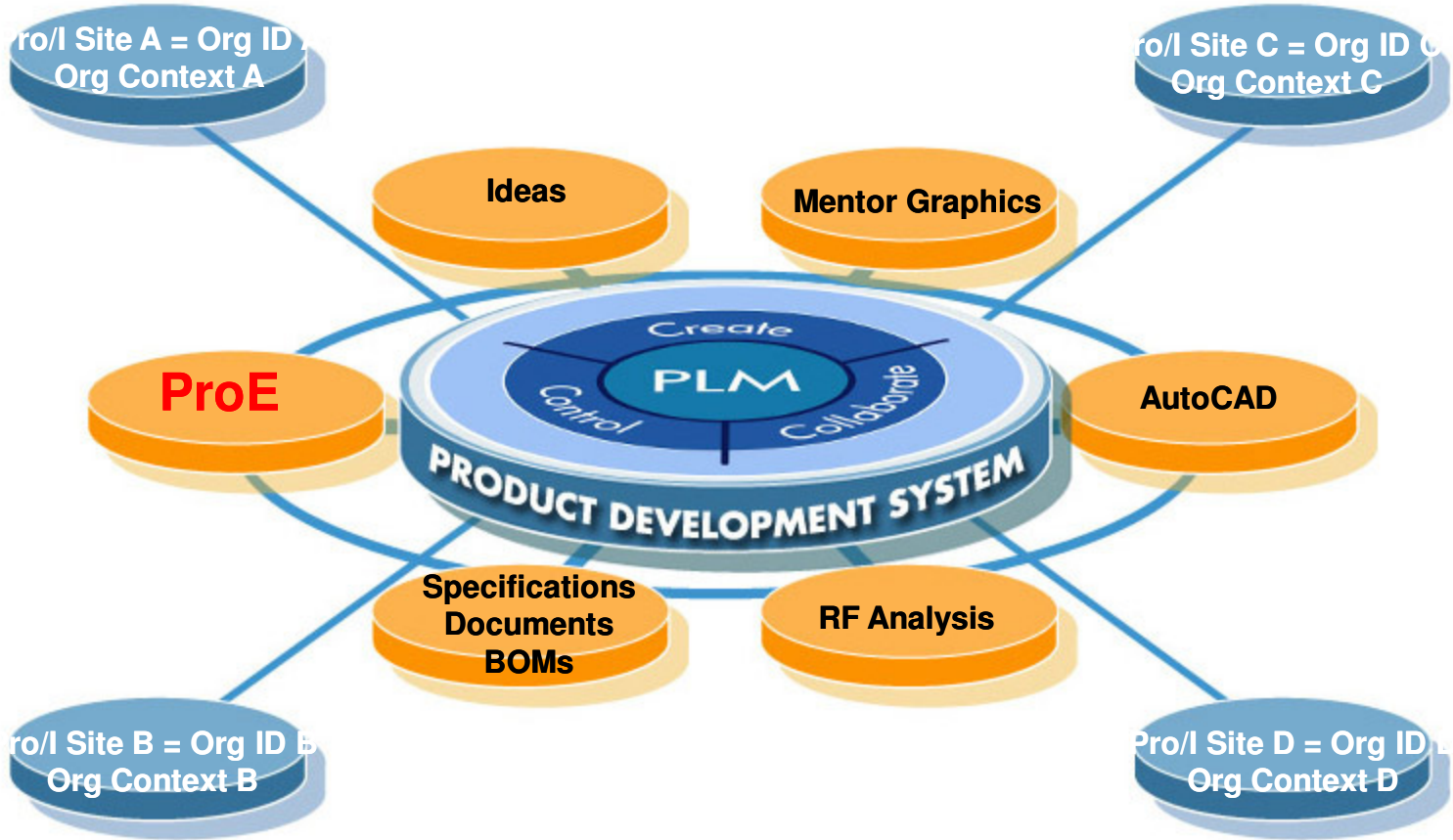

Appendix A – OOTB EPM Management in PLM

All Pro/E separate CAD types, such as assemblies, parts, drawings, sections, layouts, etc, are managed in one unique EPM CAD document object. Most common practice have the same number for various types. Due to PTC Pro/I practices and methodology, the uniqueness was the file name with extension. Pro/I was a file management tool.

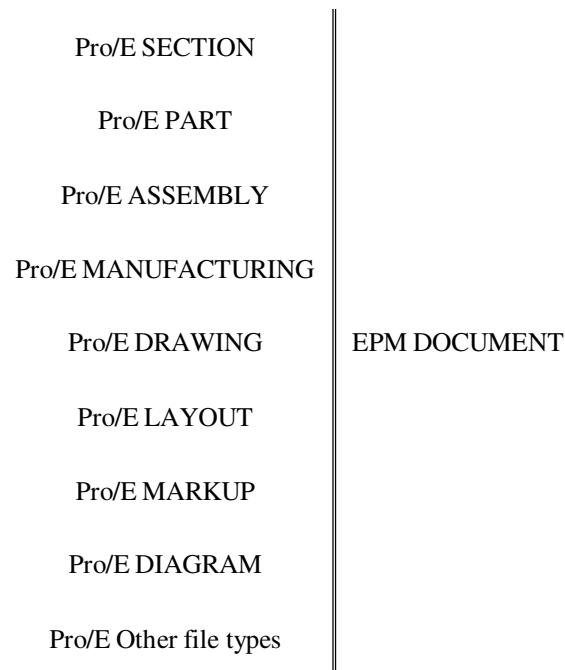

Appendix A – OOTB EPM Management in PLM

Furthermore, Windchill allows multiple CAD and Arbortext but they all still are managed by a single EPM document type. Most companies use the same number if copied from one CAD tool to another for collaboration and sharing of IP. Thus, conflicts will occur if the CAD tools use the same number and file name with extension. As a result, OOTB does not following standard practices of both business and CAD tools.

Multiple Pro/E file types	EPM DOCUMENT
Multiple ACAD types	
Multiple CATIA types	
Multiple CATIAV5 types	
Multiple SOLIDWORKS types	
Multiple UG types	
Multiple Ideas types	
Multiple ARBORTEXT content types	
Multiple CADENCE CAD types	
Multiple CCD CAD types	
Multiple INVENTOR CAD types	
Multiple ME10 CAD types	
Multiple HELIX CAD types	
Multiple ORCAD CAD types	
Multiple MENTORB, D and E CAD types	
Multiple CADD55 types	
Multiple CADSTAR types	
Multiple VISULA CAD types	
Other CAD types	

Relationship between Reference Documents and Components

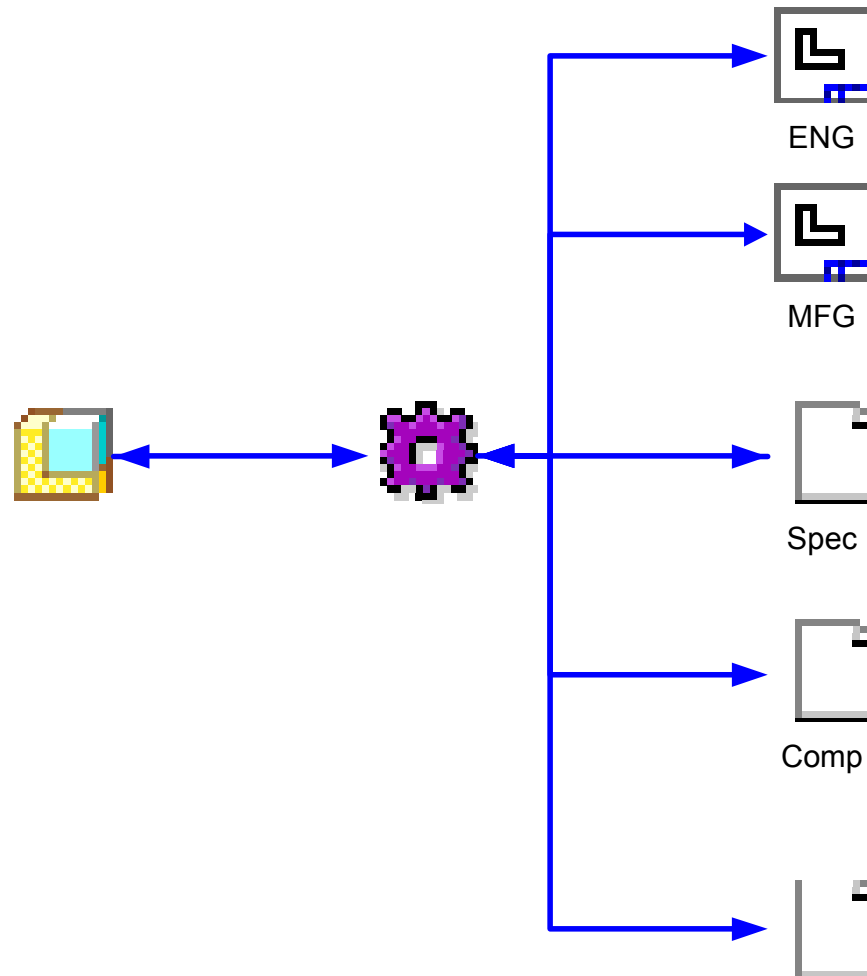

Relationship between Reference Documents and Components

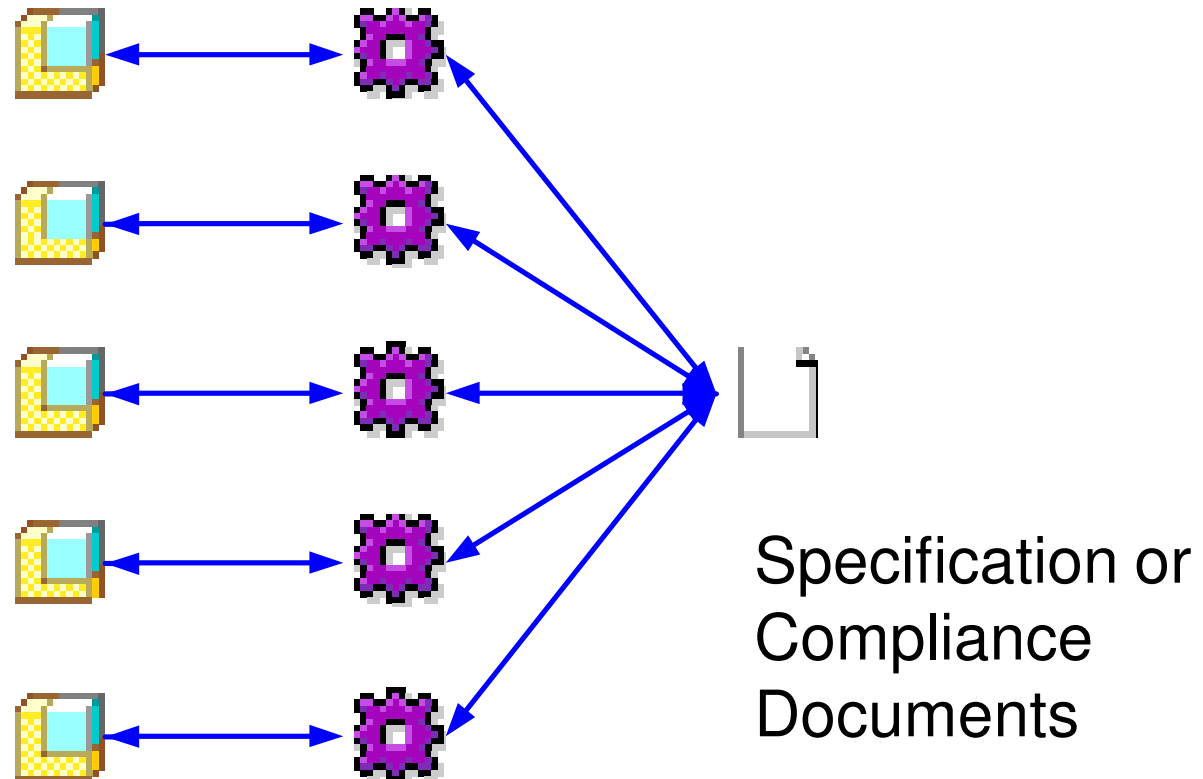

Relationship between Reference Documents and Components

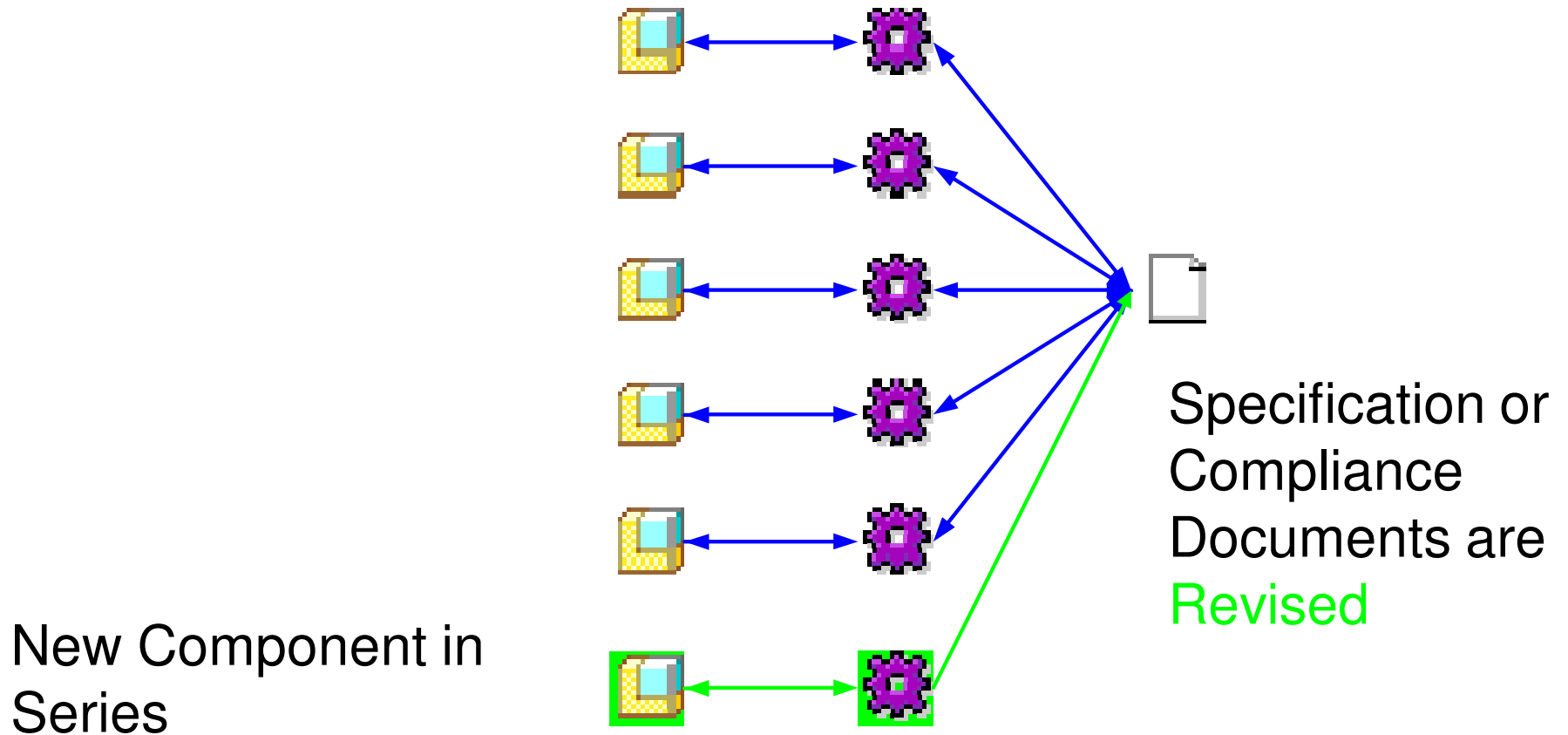

Product Spec and Component Spec

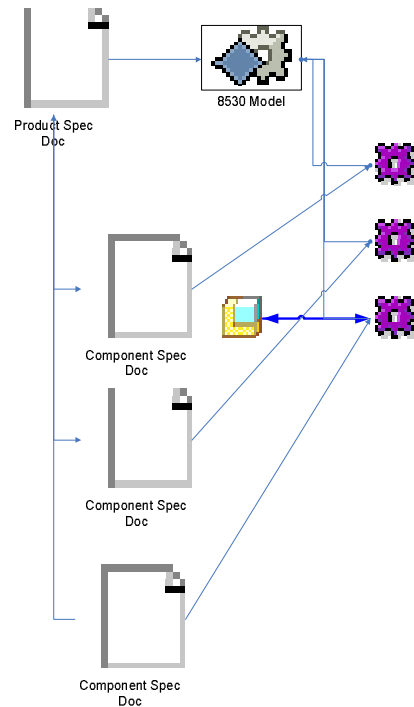

“As Process” CAD Methodology

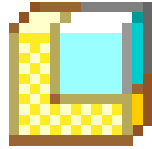

CAD Model

Name: 1234568-001.asm

File Name: 1234568-001.asm

PDF

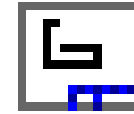

Drawing (Optional)

Number: **1234568-001**

Version: **A.1**

Baan #: **1234568-001**

Name: Housing

Attributes

- Description
- Nylon
- Black
- Smooth Textured

New Methodology Compliance

Fit or Form Change after Release

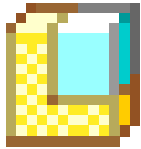

CAD Model

Number: **1234568**
Name: Housing
File Name: 1234568.asm

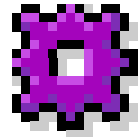

Part Representation

Number: **1234568**
Version: **1.1**
Baan #: **1234568-001**
Name: Housing
Attributes

- Description
- Teflon (temperatures)
- Black
- Smooth Textured

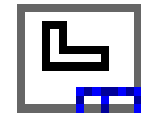

Drawing (Optional)

Number: **1234568-001**
Version: **A.1**
Baan #: **1234568-001**
Name: Housing
Attributes

- Description
- Nylon
- Black
- Smooth Textured

PLM CAD Methodology

To be proposed to the Design Automation and executive teams of standardizing engineering and manufacturing for part, ProE CAD model and drawing methodology based on best industry practices.

Standardized Component Part, CAD Model and Drawing Nomenclature Methodology

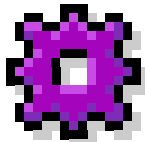

Part Representation

Number: #####

Version: -I (- no revision)

Name: 60 characters

Physical Attributes Only

- Material
- Finish
- Colour
- Dimensions



Component CAD Model

Number: #####

Version: A.I (A is Alfa)

Name: 60 characters

File Name: #####.prt
(number + ext)

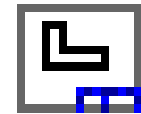

Component CAD Drawing (Optional)

Number: #####

Version: A.I (A is Alfa)

Name: 60 characters

File Name: #####.drw
(number + ext)

Attributes:

- Material
- Finish
- Colour
- RoHS

Standardized **Assembly** Part, CAD and Drawing Nomenclature Methodology

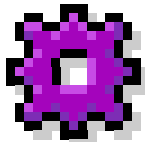

Assembly Part Representation

Number: #####
Version: **A.3** (Alpha revision sequence for assemblies)
Name: ASSY HOUSING
BOMs:

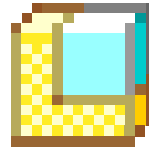

CAD Assembly Model

Number: #####
Version: A.1
Name: ASSY HOUSING
File Name: #####.asm

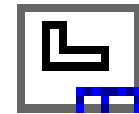

CAD Drawing

Number: #####
Version: A.1
Name: ASSY HOUSING
File Name: #####.drw

Example of a Standardized Component Part, CAD Model and Drawing

Initial Release

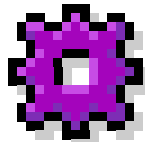

Part Representation

Number: **184786**

Version: **-1 (- no revision)**

Name: **COMPONENT
TITLE**

Physical Attributes Only

- **Material**
- **Finish**
- **Colour**
- **Dimensions**



Component CAD Model

Number: **184786**

Version: **A.1 (A is Alfa)**

Name: **COMPONENT
TITLE**

File Name: **184786.prt**
(number + ext)

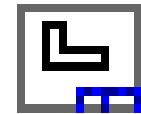

Component CAD Drawing (Optional)

Number: **184786**

Version: **A.1 (A is Alfa)**

Name: **COMPONENT TITLE**

File Name: **184786.drw**
(number + ext)

Attributes:

- **Material**
- **Finish**
- **Colour**
- **RoHS**

Example of a Standardized Component Part, CAD Model and Drawing

Drawing Text Change (No Fit, Form & Function Change) after Release

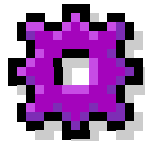

Part Representation

Number: **184786**

Version: **-I (- no revision)**

Name: **COMPONENT
TITLE**

Physical Attributes Only

- **Material**
- **Finish**
- **Colour**
- **Dimensions**



Component CAD Model

Number: **184786**

Version: **A.I (A is Alfa)**

Name: **COMPONENT
TITLE**

File Name: **184786.prt**
(number + ext)

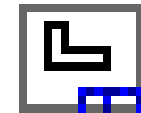

Component CAD Drawing

Number: **184786**

Version: **B.I (A is Alfa)**

Name: **COMPONENT TITLE**

File Name: **184786.drw**
(number + ext)

Attributes:

- **Material**
- **Finish**
- **Colour**
- **RoHS**

Example of a Standardized Component Part, CAD Model and Drawing

Fit or Form Change after Release

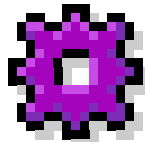

Part Representation

Number: **new number**

Version: **-I (- no revision)**

Name: **COMPONENT
TITLE**

Physical Attributes Only

- **Material**
- **Finish**
- **Colour**
- **Dimensions**



Component CAD Model

Number: **new number**

Version: **A.I (A is Alfa)**

Name: **COMPONENT
TITLE**

File Name: **new
number.prt
(number + ext)**

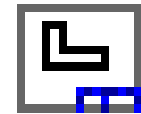

Component CAD Drawing (Optional)

Number: **new number**

Version: **A.I (A is Alfa)**

Name: **COMPONENT TITLE**

File Name: **new number.drw
(number + ext)**

Attributes:

- **Material**
- **Finish**
- **Colour**
- **RoHS**

Standardized **Assembly** Part, CAD and Drawing Nomenclature Methodology

Initial Release

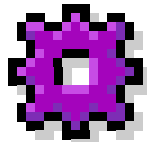

Assembly Part Representation

Number: 136814-101
Version: **A.3** (Alpha revision sequence for assemblies)
Name: COMPONENT
TITLE
BOMs:

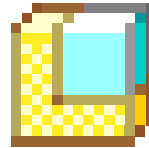

CAD Assembly Model

Number: 136814-101
Version: **A.1**
Name: COMPONENT
TITLE

File Name: 136814-101.asm

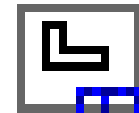

CAD Drawing

Number: 136814-101
Version: **A.1**
Name: COMPONENT
TITLE

File Name: 136814-101.drw

Standardized **Assembly** Part, CAD and Drawing Nomenclature Methodology

Drawing Text Change (No Fit, Form & Function Change) after Release

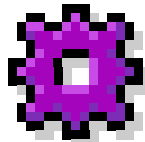

Assembly Part Representation

Number: 136814-101
Version: **A.3** (Alpha revision sequence for assemblies)
Name: COMPONENT
TITLE
BOMs:

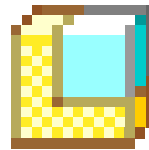

CAD Assembly Model

Number: 136814-101
Version: **A.1**
Name: COMPONENT
TITLE
File Name: 136814-101.asm

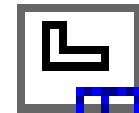

CAD Drawing

Number: 136814-101
Version: **B.1**
Name: COMPONENT
TITLE
File Name: 136814-101.drw

Standardized **Assembly** Part, CAD and Drawing Nomenclature Methodology

Component change resulting in a new assembly number

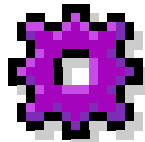

Assembly Part Representation

Number: **new number**

Version: **A.3** (Alpha revision sequence for assemblies)

Name: COMPONENT
TITLE

BOMs:

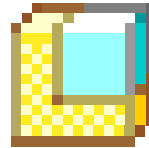

CAD Assembly Model

Number: **new number**

Version: **A.1**

Name: COMPONENT
TITLE

File Name: **new number.asm**

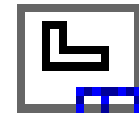

CAD Drawing

Number: **new number**

Version: **A.1**

Name: COMPONENT
TITLE

File Name: **new number.drw**

Standardized **Assembly** Part, CAD and Drawing Nomenclature Methodology

Resulting change in next higher assembly revision

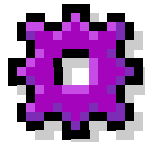

Assembly Part Representation

Number: #####
Version: **B.3** (Alpha revision sequence for assemblies)
Name: COMPONENT
TITLE
BOMs:

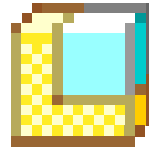

CAD Assembly Model

Number: #####
Version: **B.1**
Name: COMPONENT
TITLE
File Name: #####.asm

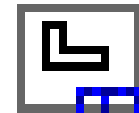

CAD Drawing

Number: #####
Version: **B.1**
Name: COMPONENT
TITLE
File Name: #####.drw

Advantages of Standardized Methodology with PLM

- **Visible standard changes in the organization with fit, form and function**
- **Alignment with current bin numbering in MFG**
- **PLM can provide better controls to enforce this methodology with workaround in different PLM libraries and subfolders**