

Upgrade to bring your team to the next level!

- PTC Creo 3.0 Schools edition is now available to all FIRST teams
- To register go to: <http://www.ptc.com/go/creoforstudents>
- Standalone and Lab (floating) licenses are available

- We plan to start the webinar at 7 PM. In the meantime, we hope you enjoy our silent pre-webinar slideshow as people join!

PTC Creo 3.0

Design Better Products, Faster



What's new in PTC Creo 3.0?

**Breakthrough Multi-CAD
Technology**



**Concept Design
Improvements**

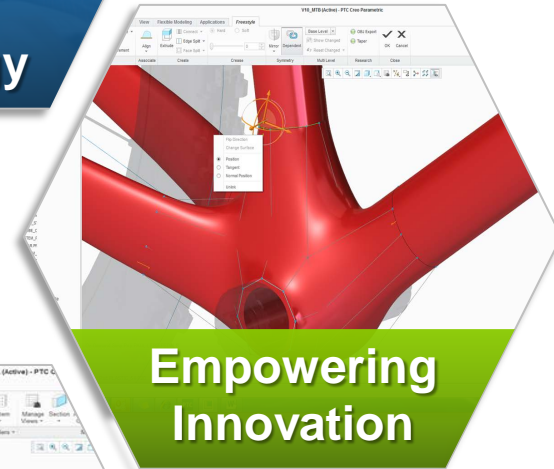

**PTC Creo Efficiency
Improvements**



Breakthrough Multi-CAD Technology



**Unite
Technology**

Concept Design Improvements



**Empowering
Innovation**

PTC Creo Efficiency Improvements

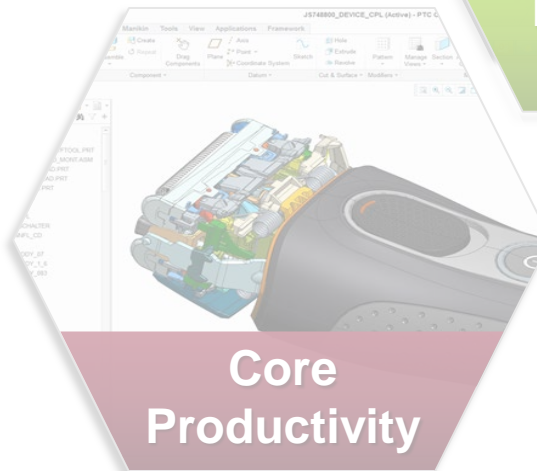

**Core
Productivity**

Enabling Optimal Multi-CAD Collaboration and Consolidation

- **Import** all common 3D CAD formats
 - SolidWorks, CATIA, NX, Inventor, SolidEdge
- **Open** key competitive 3D CAD formats
 - SolidWorks, NX, and CATIA
- **Automatically update** new versions of non-PTC Creo data within your designs
- **Save As** key competitive 3D CAD formats
 - SolidWorks, NX, and CATIA formats



**Breakthrough Multi-CAD
Technology**



**Unite
Technology**

**Concept Design
Improvements**

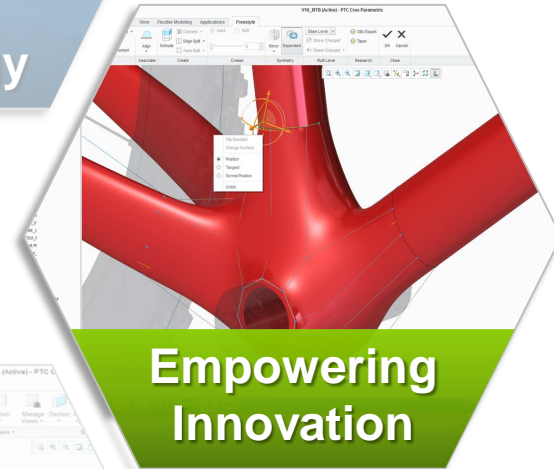

**Empowering
Innovation**

**PTC Creo Efficiency
Improvements**

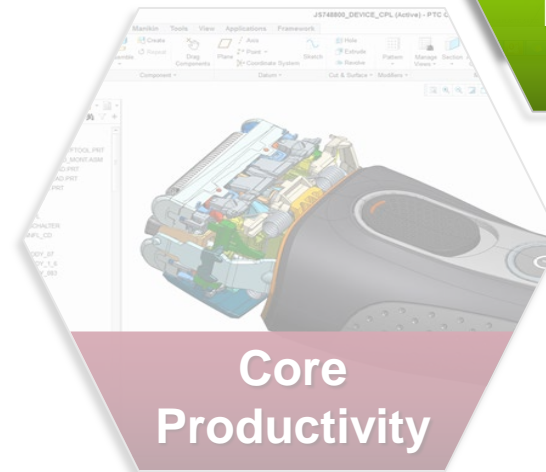

**Core
Productivity**

Dedicated tools for concept development that support the seamless flow of design intent into the detail design process.

EMPOWERING INNOVATION

92% OF PEOPLE SAY THEY WOULD BENEFIT IMMENSELY BY EXPLORING MORE CONCEPT DESIGN ALTERNATIVES¹

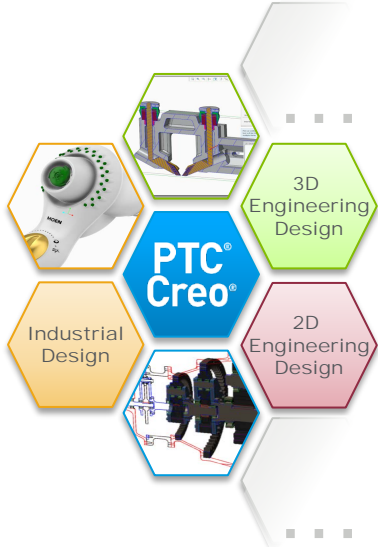

¹ Trends in Concept Design, PTC Study – July 2011

Industrial Design with Freestyle

- **Capabilities**

- Rapid freeform surface creation
- Direct manipulation with 3D dragger
- **NEW!** Parametric control over freeform geometry
- Trim, merge, round, thicken, solidify to make the model solid
- **NEW!** Join faces and edges
- High quality, curvature continuous, manufacturable surfaces

- **Benefits**

- Quickly create the highest quality and most innovative products
- Accelerate concept design
- Generate more proposed concepts

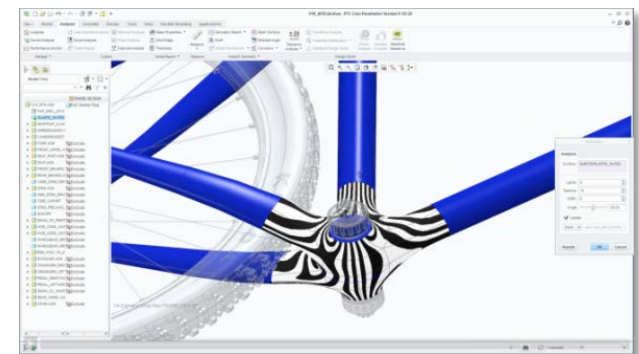
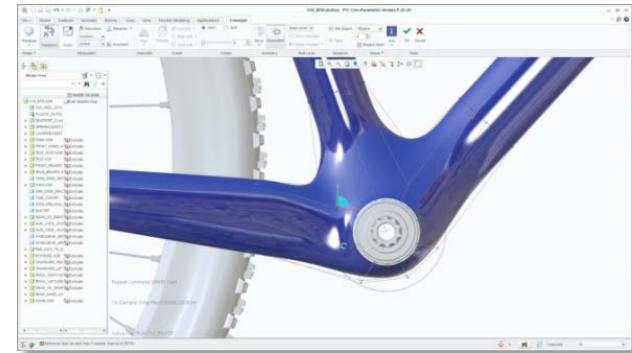
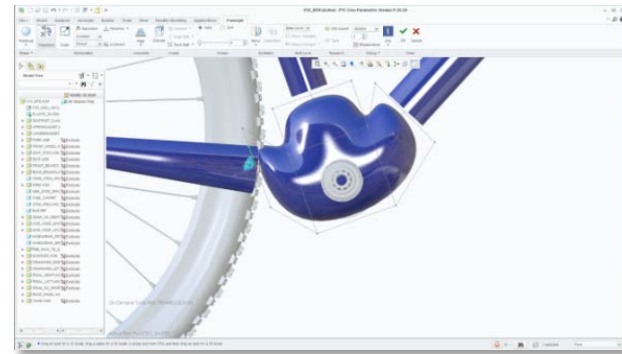

Quickly iterate parametric designs with PTC Creo Design Exploration Extension (DEX)

What is DEX?

- A dedicated environment for enabling the quick and easy investigation of alternative concept designs within the parametric environment
- A significant enhancement to the process of developing design alternatives, investigating modeling approaches and safely understanding the consequences of design changes

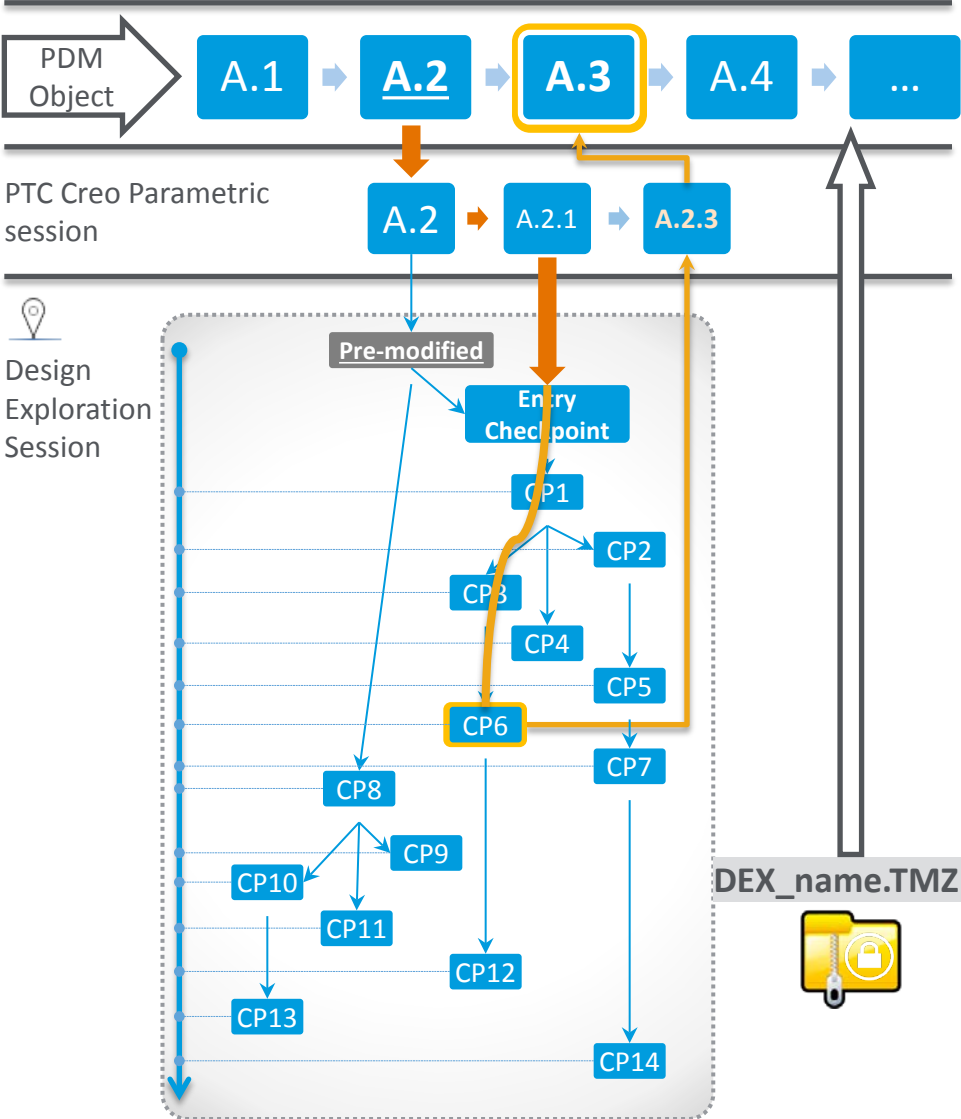

PTC Creo Design Exploration Extension

- **Capabilities**

- Create unlimited checkpoints and branches of design alternatives
- Instantly toggle between checkpoints
- Save all checkpoints in a lightweight format for later reference
- Store and access DEX data at any time

- **Benefits**

- Explore design changes safely without risking original designs or committing to any change
- Simultaneously develop different ideas and evaluate all options before making decisions
- Eliminate manual data duplication and tedious session clean-up for loading and reloading different versions
- Browse exploration checkpoints in a “decision tree” for interactive design review

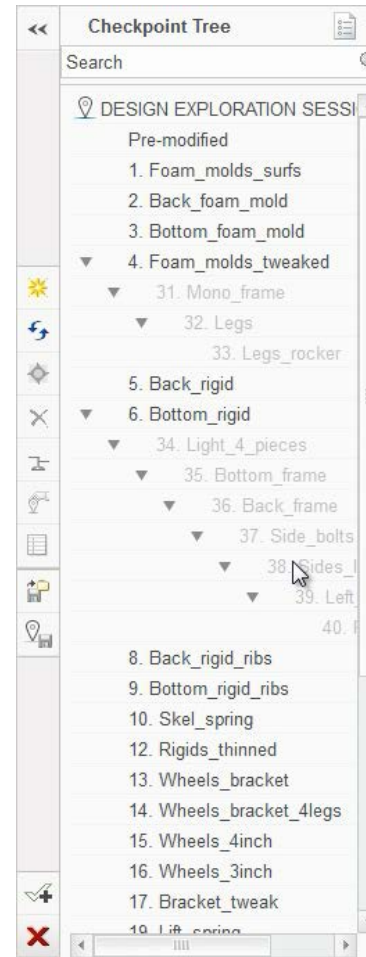

Benefits

- **Seamless Interoperability**
 - Use data across 2D & 3D, direct and parametric environments
- **Flexibility and Control**
 - Combine freeform and parametric modeling
- **Support RFQ efforts**
 - Quickly develop 3D concepts using direct modeling that can be used in a parametric environment
- **Quickly Evaluate Design Alternatives**
 - Dedicated 'Sandbox' environment supporting the development of design alternatives or design approaches

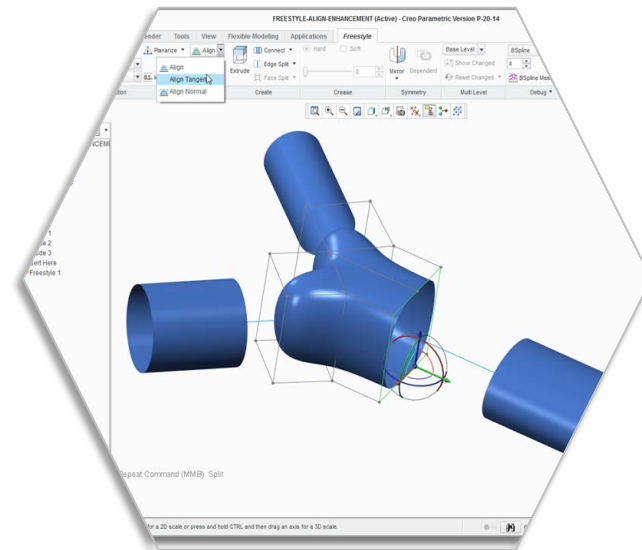
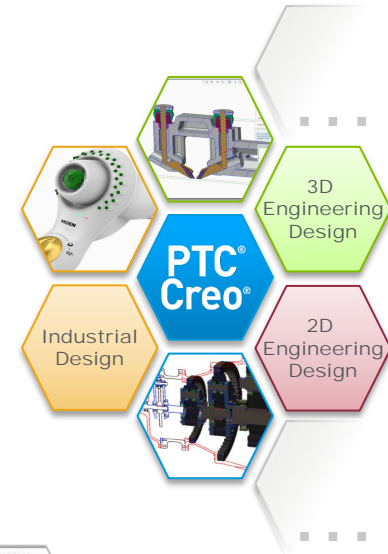

**Breakthrough Multi-CAD
Technology**



**Unite
Technology**

**Concept Design
Improvements**

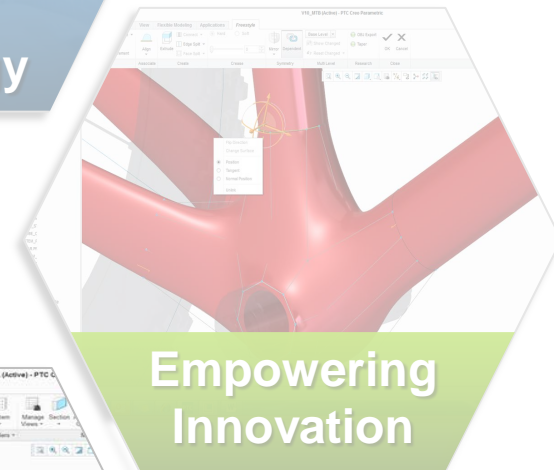

**Empowering
Innovation**

**PTC Creo Efficiency
Improvements**



**Core
Productivity**

Enhancements in PTC Creo Parametric

- New Getting Started Experience
- Integrated Hardware Libraries
- Chordal Round
- New PTC Mathcad Integration*
- Redesigned Reroute
- New 3D Thickness Check
- Graphical Realism
- New Note Creation Tools and Workflows

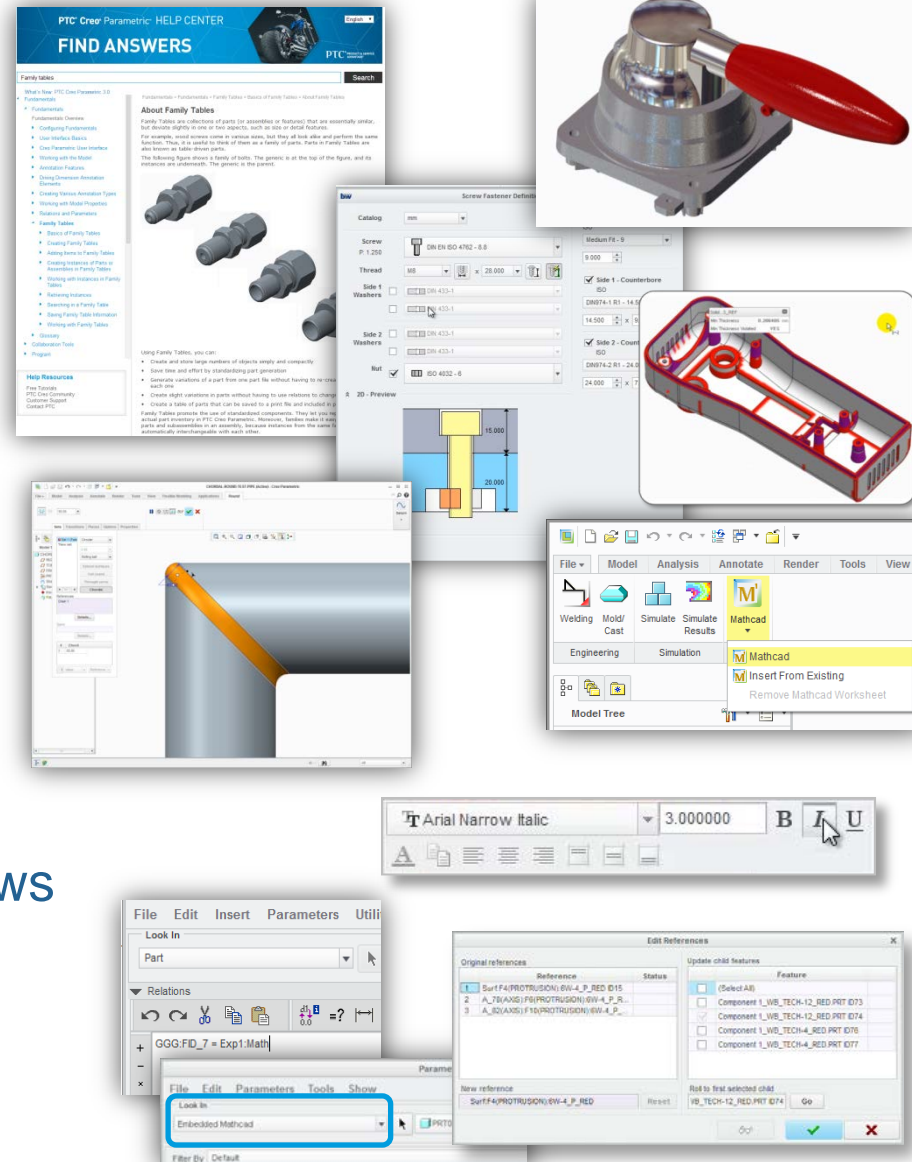

- **New Getting Started Experience**

- Revamped Help, Google indexed and searchable on the web
- Startup Tutorials shipped with the product
- Additional tutorials downloaded through Learning Exchange
- 100+ What's New Videos available on Learning Exchange

- **Integrated Hardware Libraries**

- Nuts, Bolts, Washers, Screws
- Auto hardware selection
- Auto counterbore
- Pattern placement

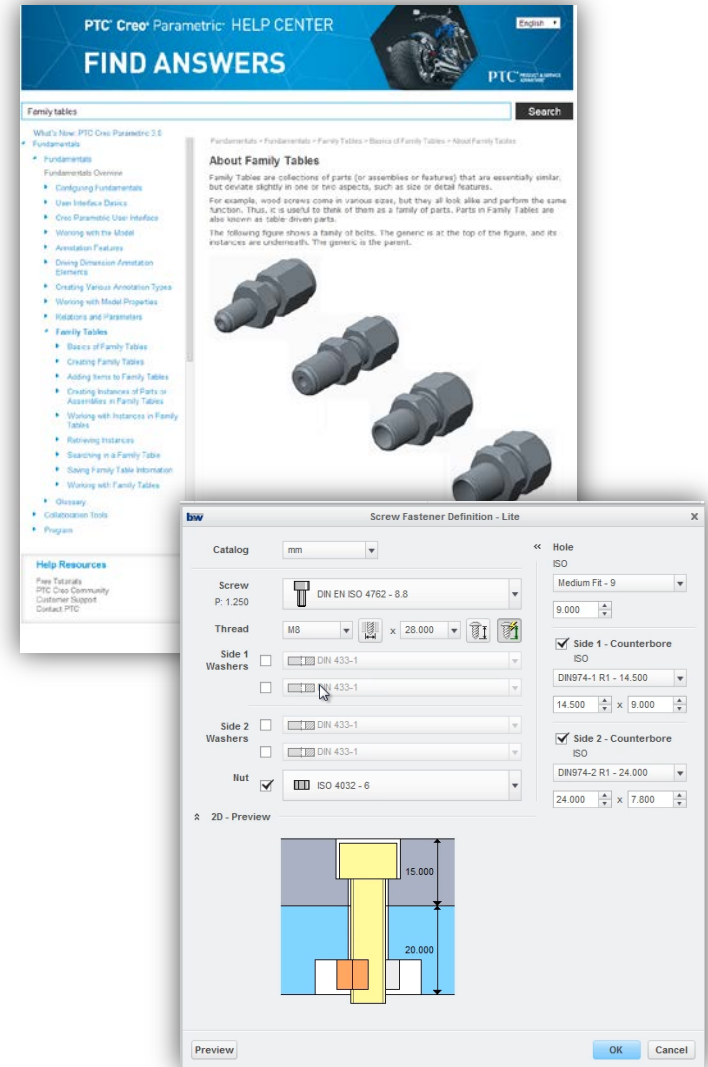

- **Chordal Round**
 - Constant width useful for many cases
- **New PTC Mathcad Integration**
 - Mathcad Express is shipped with every seat of PTC Creo Parametric.
 - Embed Mathcad worksheet in any PTC Creo part or assembly
 - Connect input/outputs from Mathcad to parameters in PTC Creo Parametric
- **Redesigned Reroute**
 - Reroute simplified
 - Broader power – easily transition to multi-feature reroute
 - Retained image of lost references available to guide selection of new references

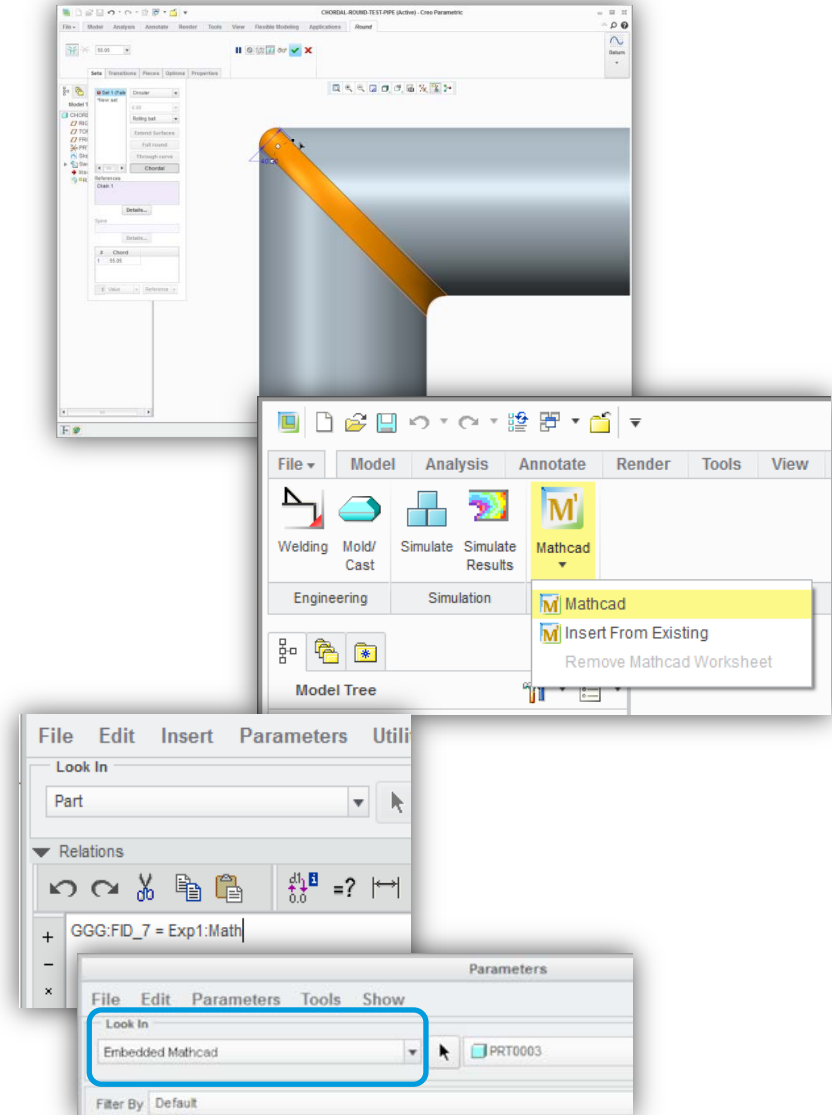

- New 3D Thickness Check
- Graphical Realism
- New Note Creation Tools and Workflows
 - Properties floating dashboard
 - Simple note import
 - Easy parameter mapping – no special syntax needed

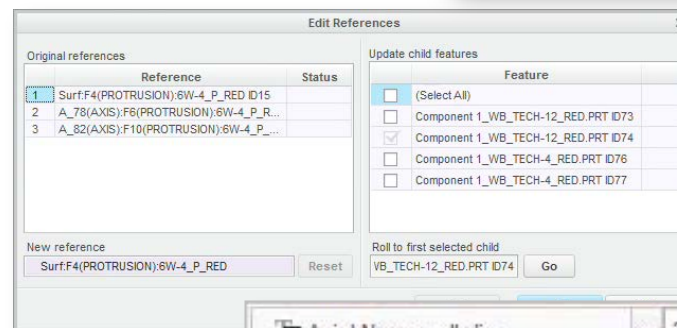

Outside of Core PTC Creo Parametric, PTC Creo Layout and PTC Creo Direct

- **PTC Creo Simulate**

- Sliding Contact with Friction
 - Finite friction for individual contact interfaces
 - Different coefficients for Static and Dynamic friction
 - Automatic calculation of maximum tangential traction, normal force, contact area, slippage coefficients
- Contact between intent surfaces
- All new results creation workflows and user experience

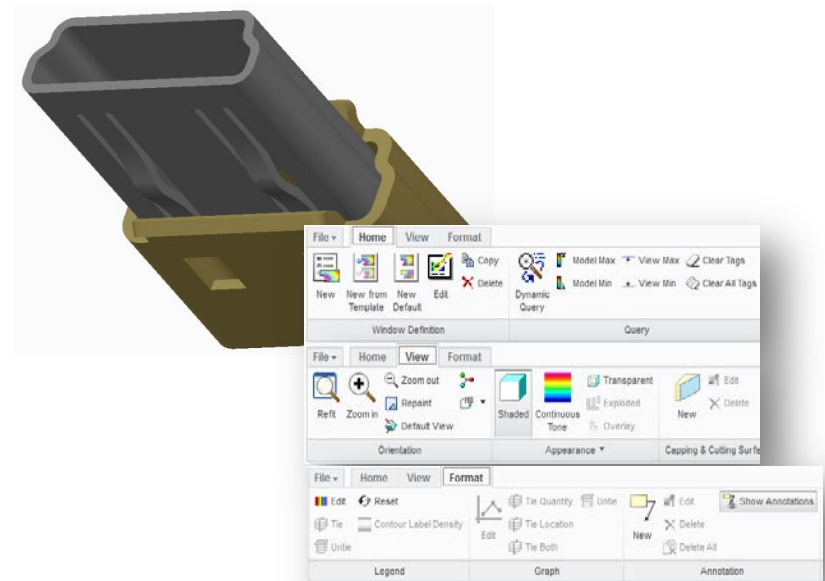

- **PTC Creo Flexible Modeling Extension**

- Tangency propagation control
 - Includes Round/Chamfer handling
- New Flex Pattern

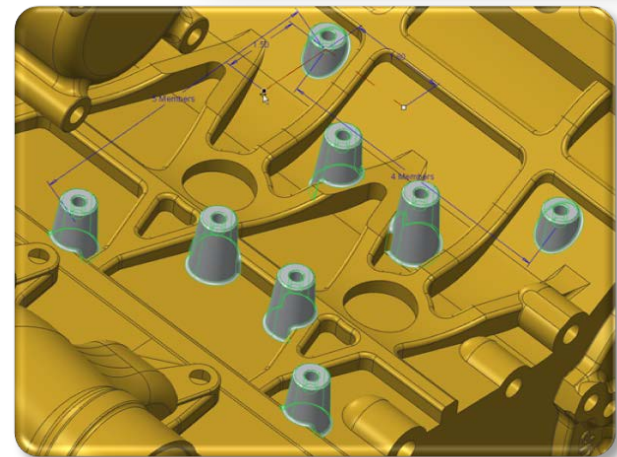

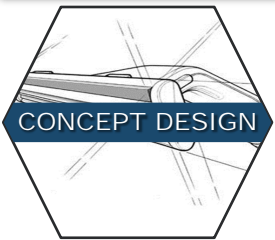

- Creating stylized concepts
- Creating new concepts from existing models
- Creating new concepts in 2D

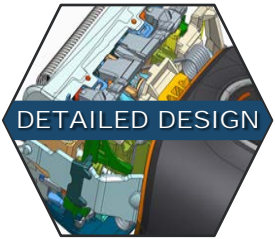

- Dealing with late design changes
- Working in a multi-CAD environment
- Working with large assemblies
- Electro-mechanical co-design
- Creating modular products

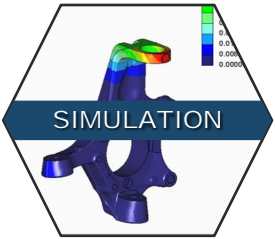

- Validating designs against functional requirements
- Associate design and analysis
- Preparing models for CAE analysis

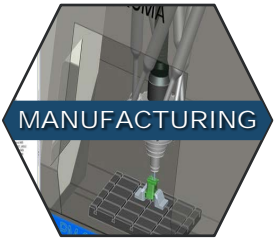

- Using 3D data in manufacturing

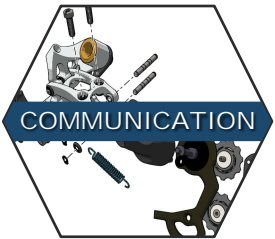

- Creating 3D technical illustrations