

PTC Global **Services**

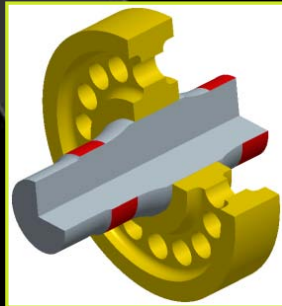
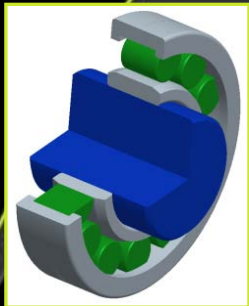

## The New Contact with Friction Feature in Mechanica WF 4.0 – Theoretical Fundamentals and Application Examples –

Dr.-Ing. Roland Jakel, PTC GSO CER

English Translation of the „Theoretical Fundamentals“-Part  
by Andy Deighton, PTC UK

English Version of the Presentation for the 1st SAXSIM | TU Chemnitz  
28-April-2009

# Contents

---

## Brief Introduction of PTC Simulation Services

### Contact Theory:

- Introduction to the penalty method used in Mechanics contact analysis
- Explanation of the functionality used in contact with infinite friction
- Overview of the contact specific measures
- Tips, for when nothing else works...

### Application examples of typical industrial components:

- Rolling load in a cylindrical roller bearing (Hertzian contact, friction free)
- Torque transmission in a shaft-hub connection with shrink fit

## PTC Simulation Services Introduction

---

- PTC Global Services provides services for our own simulation products:
  - Pro/ENGINEER Mechanica as a FEA tool with p-method for structural mechanical, thermal and thermo-mechanical analysis
  - Pro/ENGINEER MDX and MDO (Mechanism Design Extension and Mechanism Dynamics Option) for kinematic and dynamic multi-body simulations
- The benefits are accomplished as following:
  - Required calculations
  - Development of the required analysis and optimization, working with the design team, directly on the working CAD data, including adoption of mechanical systems engineering tasks
  - On-site simulation consulting → Software and calculation method knowledge transfer
  - Simulation training and workshops from PTC University
- The following slides show some examples of relevant references on the theme of contact calculations. Numerous other references from other clients and to other simulation issues can be provided upon request.

# PTC University Further Educates Bosch Diesel Systems in Nonlinear Contact Analysis with Pro/ENGINEER Mechanica®

As the world's leading diesel systems manufacturer, the Bosch Diesel Systems Division, headquartered in Stuttgart, Germany, develops, applies and produces diesel injection systems which contribute to making vehicles cleaner and more economical. In the very early development phase, Finite Element analysis and optimization with Mechanica® assures that their highly pressurized systems work as reliable in their later service life.

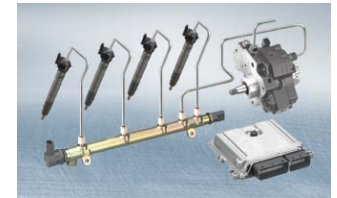

## BUSINESS INITIATIVE

- Bosch DS wanted to extend its engineers' skills in nonlinear Mechanica contact simulation and to familiarize them with the new developed friction contact model of the latest Mechanica release

## SOLUTION

- PTC University offered a specially customized in-center training workshop containing knowledge transfer in Mechanica contact theory and analysis, and furthermore the opportunity to discuss and analyze typical Bosch DS products

## RESULT

- Acquired knowledge in the frictionless and friction containing contact model provided in Pro/ENGINEER Mechanica
- Acquired skills in setting up idealized, speed and accuracy optimized contact models
- Ability to assure the result quality of nonlinear contact analysis by carefully creating and interpreting contact measures and postprocessor plots

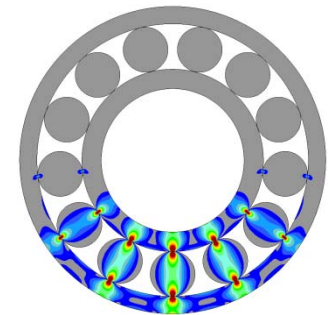

Top: A typical Bosch common rail Diesel injection system containing several pressurized components and contact analysis tasks  
Bottom: A PTC University contact training example - von Mises stress distribution within a cylindrical roller bearing acc. to the Hertz theory

**“PTC University provided a first-rate Mechanica contact workshop that delivered the exact information we were looking for. In the training, our Mechanica Models were discussed and analyzed with reasonable idealizations. Typical difficulties and problems we observe when setting up and running contact analyses were treated and helpful solutions were provided.”**

Dipl.-Ing. Matthias Brunner, Engineering Technical Information Processing, Diesel Systems, Robert Bosch GmbH

## PTC University Educates Bosch Rexroth Engineers in Advanced Nonlinear Contact and Bolt Simulation with the Pro/MECHANICA FEM Code

Bosch Rexroth AG, headquartered in Lohr am Main, Germany, is a developer, producer and supplier of drive and control technologies for hydraulic, electric, pneumatic or mechanical applications. In order to increase product quality in spite of reduced development time, the PTC University was charged with the further education in advanced contact and bolt analysis with Pro/MECHANICA.

### BUSINESS INITIATIVE

- Bosch Rexroth requested on-site Pro/MECHANICA contact & bolt simulation workshops for their design and CAE engineers developing hydraulic equipment.

### SOLUTION

- PTC offered simulation workshops providing basic principles of bolt analysis, necessary software knowledge, typical application tasks and furthermore solutions for special customer examples.

### RESULT

- Acquired knowledge about the contact theory used in Pro/MECHANICA and methods to assure numeric solution quality
- Acquired solution roadmaps for typical bolt analysis tasks
- Critical bolted designs can now be analyzed and optimized in Pro/MECHANICA before prototypes are being built and tested.

**Rexroth**  
Bosch Group

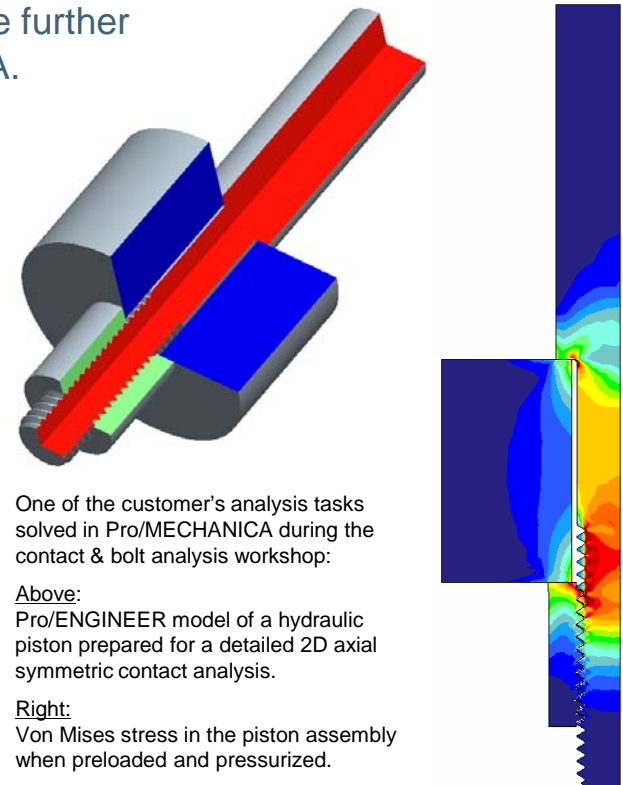

One of the customer's analysis tasks solved in Pro/MECHANICA during the contact & bolt analysis workshop:

Above:  
Pro/ENGINEER model of a hydraulic piston prepared for a detailed 2D axial symmetric contact analysis.

Right:  
Von Mises stress in the piston assembly when preloaded and pressurized.

**“The Pro/MECHANICA simulation training provided by the PTC University exactly met what we needed: Solution methods in Pro/MECHANICA for all types of bolted connections with different precision demands, starting from just obtaining force relations up to evaluating exact load and stress distributions in each single thread turn.”**

Dipl.-Ing. Katja Mild, Group Leader R&D, Bosch Rexroth AG

## PTC Global Services Performs Advanced FEM Bolt Analysis for P&S

P&S Tensioning Systems Ltd., located in St. Gallenkappel, Switzerland, is known worldwide for its SUPERBOLT® Multi Jackbolt Tensioners, which are designed as direct replacements for hex nuts. The main thread serves to position the tensioner on the bolt or stud against the hardened washer and the load bearing surface. Once it is positioned, actual tensioning of the bolt or stud is accomplished with simple hand tools by torquing the jackbolts which encircle the main thread.



### BUSINESS INITIATIVE

- P&S wanted to show that their tensioning system also has big advantages when used in a crosshead bolted connection where the load untypically is not introduced into the clamped parts, but directly into the bolt. These connections are critical regarding rupture. No analytical standards or guidelines exist up to now how to analyze this type of bolted connection.

### SOLUTION

- PTC Global Services Consulting analyzed the existing crosshead connection and the alternative with the SUPERBOLT® Tensioner within advanced Pro/MECHANICA Structure contact analyses based on customer DXF data and provided a detailed presentation.

### RESULT

- Precise location of the overloaded area where typically rupture appears when a standard nut is used: Here, the first groove of the bolt thread inside the crosshead is critically loaded.
- Representation of the more equal load distribution along the thread when the SUPERBOLT® Tensioner is used.

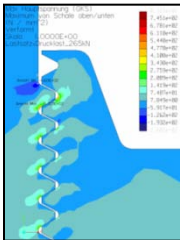

**“On an international bolt application conference we learned how PTC analyzed a similar bolted connection within an ARIANE 5 rocket upper stage of EADS/CNES. We wanted to take advantage of this unique knowledge for our own product and were fully satisfied with the results obtained by the use of PTC’s Pro/MECHANICA Structure FEM code, which exactly match our observations in the field.”**

Norbert Schneider, Technical Director, P&S Tensioning Systems Ltd.

## PTC Global Services Consults RENK in 3D-Contact and Bolt FEM Analysis

RENK Aktiengesellschaft, a member of the MAN group, develops and produces its slide bearings and clutches directly at the production facilities in Hannover, Germany. The products are rated via computer programs and designed with the CAD system Pro/ENGINEER. This provides RENK with a high degree of flexibility when it comes to quickly meet customer requirements.

### BUSINESS INITIATIVE

- For assuring strength and reliability of a very compact, bolted and highly loaded slide bearing housing, RENK AG was asking for consulting support in advanced FEM simulation with Pro/MECHANICA Structure

### SOLUTION

- PTC Global Services offered a Pro/MECHANICA Structure consulting for 3D-contact and fastener analysis at the customer's plant. This contained prepared example assemblies for further education as well as direct work and demonstrations with the original customer assembly for solving this analysis problem.

### RESULT

- Weak point in housing design approach identified and solution proposed
- Deep knowledge and several new methods learned how to handle contact problems and how to apply Pro/MECHANICA Structure for bolted assemblies
- Better understanding of the used penalty method for contact analysis
- Acquired ability to independently solve similar problems without further consulting

**“The FEM simulation consulting, which was provided very quickly in excellent quality and with deep background knowledge, gave us valuable feedback about our own analysis procedures and showed us additional methods in applying the Pro/MECHANICA software more efficient.”**

Burghard Kohring, Project Manager, RENK AG Hannover

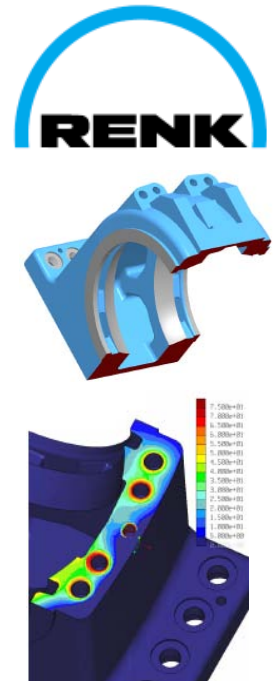

Casted housing of a slide bearing with contact pressure distribution at the interstice, coming from bolt pretension and operational shock load

# PTC Global Services Supports Carl Zeiss Camera Lens Division in Analyzing and Optimizing Clamped, Achromatic Lens Elements with Pro/MECHANICA

The name Carl Zeiss is a byword for pioneering performance in camera lenses. For over 150 years, the technology pacesetter has been pushing back the frontiers of precision technology. Today, modern FEM tools are used to analyze deformations and strength of lens elements under mechanical and thermal loading to assure highest precision and reliability.



We make it visible.

## BUSINESS INITIATIVE

- Zeiss wanted to study the behavior of their achromatic lens elements consisting of glass with different thermal expansions and glued with a  $\mu\text{m}$ -thin layer, when preloaded by locking rings and thermally loaded.

## SOLUTION

- PTC Global Services developed an analysis model of a clamped achromatic lens element within an extensive on-site Carl Zeiss employee consulting.

## RESULT

- Detailed knowledge transferred to Zeiss employees how to use Pro/MECHANICA for advanced contact analyses with micrometer-small contact areas and extremely thin glue layers between the lens elements
- Ready-to-run Pro/MECHANICA Finite Element and MATHCAD Model for further studies delivered

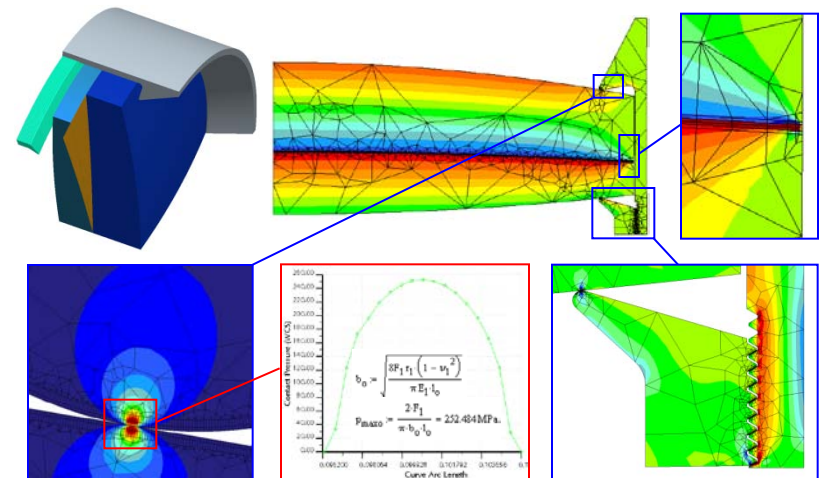

Top left: Pro/ENGINEER model of the fitted lens elements with the thin glue layer  
Top center: P-meshed Pro/MECHANICA model showing radial thermal stress  
Top right: Thermal stress in the  $\mu\text{m}$ -thin glue layer between the lens elements  
Bottom left: Shear stress in lens element and fitting according to Hertz contact theory  
Bottom center: Contact pressure distribution from Pro/MECHANICA at locking ring lobe and corresponding analytical equations derived in MATHCAD for comparison  
Bottom right: Axial stress near thread of locking ring

**“The outstanding expert knowledge provided by PTC Global Services enabled us to perform our own detailed, precise and further-going finite element studies with Pro/MECHANICA. This will allow us to develop and deliver cine and camera lenses still a notch above our actual ones, working yet more precise under extreme environmental conditions.”**

Dipl.-Ing. Christian Bittner, Product Development Carl Zeiss AG Camera Lens Division



## PTC Global Services Supports ZF Friedrichshafen AG in Finite Element Analysis

ZF develops and produces products serving the mobility of human beings and goods. Innovations in Driveline and Chassis Technology provide increased driving dynamics, safety, comfort and economy as well as lower fuel consumption and emissions in the vehicles of their customers: By land, by sea and in the air. ZF's main priority is to meet its customers' needs by using leading technology, quality and service. This is the key to strengthening their international market position.



### BUSINESS INITIATIVE

- ZF uses Pro/ENGINEER Mechanics very early within the design process to select the best between different initial design ideas and to further optimize these ideas. For the necessary consequent education of the designers, PTC was charged

### SOLUTION

- PTC offered a Pro/ENGINEER Mechanics Finite Element Analysis training that was enriched with special customer examples

### RESULT

- Significantly enhanced FEM analysis knowledge and Pro/ENGINEER Mechanics application skills of the mechanical designers
- Solved several typical ZF product analysis tasks during the training
- Decreased design loops between design and subsequent analysis departments since the first prototypes will be pre-optimized

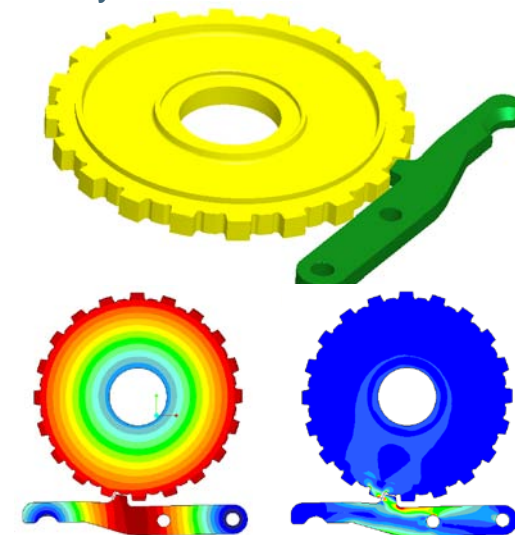

Pro/MECHANICA contact analysis of a torque loaded park lock mechanism within a ZF gearbox: 3D Pro/E-Model (top), displacements (bottom left), stress (bottom right), created within half of an hour during the customized training.

**“PTC Global Services gave our mechanical designers an excellent and valuable technical, as well as didactical, further education in structural analysis with Pro/ENGINEER Mechanics. Furthermore, we could observe during the training how our typical given analysis tasks were solved live in a very short time span with the PTC software.”**

Jörg Sielemann, Manager CAD/CAM Development an Application

# PTC Global Services Supports ZF Test Systems in Advanced Nonlinear Contact and Bolt Simulation with Pro/ENGINEER® Mechanical®

ZF Test Systems, a business unit of ZF Passau GmbH in Germany, offers its customers the know-how of a major manufacturing group with the flexibility of a small division. Just 70 employees develop and produce tailor-made and ready-to-use test rigs for automotive component and system tests like rolling noise, oscillations, vehicle stiffness or power losses.



## BUSINESS INITIATIVE

- Since all test rigs are unique and individually designed for the actual customer demand, ZF uses Pro/ENGINEER Mechanical during the full development phase. Now, detailed fastener analysis shall also be performed within this FEM code

## SOLUTION

- PTC offered an individual simulation workshop that treated bolt theory, explained prepared examples and solved bolt analysis tasks of new ZF products under development

## RESULT

- Analyzing the behavior of bolted connections numerically within Pro/ENGINEER Mechanical provides much higher accuracy compared to the previously performed hand analyses
- Complete assemblies can now be analyzed, including all fasteners even with non-regular geometry, using nonlinear contact for full accuracy or simplifying linearizations

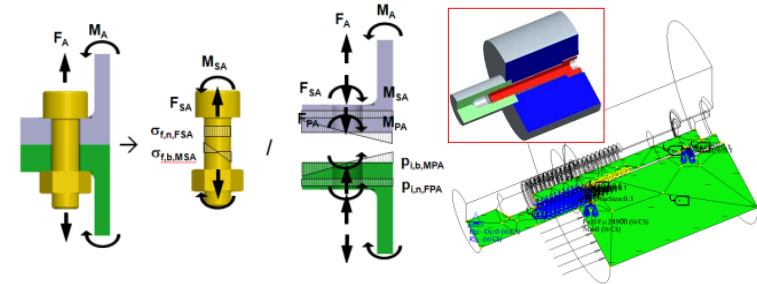
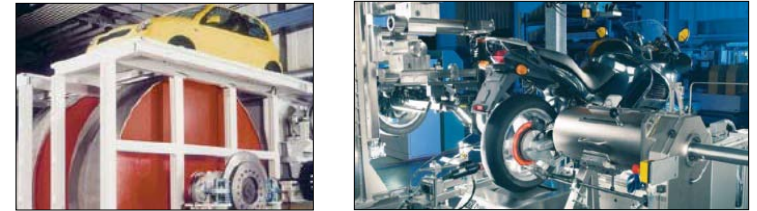

**Top:** Two of many ZF Test Systems products: Test bench for wheel behavior on different road surfaces (left); Brake noise test bench (right)

**Bottom left:** Tension and bending loaded bolted flange with applied forces and moments, explaining the simplified linearized approach

**Bottom right:** Centrally loaded bolted connection acc. to the German VDI-Guideline 2230 "Systematic Calculation of High Duty Bolted Joints"; small image: Pro/ENGINEER model (pressure loaded bolted piston), wireframe image: Meshed, fully detailed 2D axial symmetric contact model containing all thread flanks (Pro/ENGINEER Mechanical integrated mode)

**"The comprehensive way the bolt theory was explained in the workshop showed us the deep engineering experience PTC has in this field. The proposed, elegant method to linearize bolted connections in Pro/ENGINEER Mechanical under certain conditions allows us to analyze them in huge Pro/ENGINEER assemblies even in our dynamic frequency and time analyses using the modal approach."**

Jens Eisenbeiß, Senior Manager Mechanical Design Test Systems, ZF Passau GmbH

## Contact Analysis in Mechanics

---

### Assumptions for contact analysis in Mechanics (Wildfire 4.0):

- Material is linear elastic
- Force equilibrium is based on un-deformed structure (→ only “small deformations” permitted!)
- Contact is either perfect friction free or – for selection of potential friction with contact – the coefficient of friction is infinitely large

### Supported model types for contact:

- 3D solid models
  - 2D plane stress
  - 2D plane strain
  - 2D axisymmetric
- (Shells and beams are not supported)

## Introduction to the Penalty Method used in Mechanics (1)

### Principals of the penalty method:

- For a static contact analysis, the following system of equations are solved:

$$\left| K(\vec{u}, \vec{f}) \right| \cdot \vec{u} = \vec{f}$$

- The non-linear stiffness matrix  $K$  is a function of the nonlinear force vector  $f$  and the displacement vector  $u$
- In practice, the contact between the surfaces is achieved by nonlinear spring elements ("gap element") - this is invisible to the user.
- If a penetration of a contact edge is calculated (as a result of external loads or because of an interference fit), Mechanics tries to iteratively set the penetration depth by adjusting the stiffness of the spring elements to a small value, so that both local stresses and the global load balance is accurately achieved. A penetration depth of zero is not mathematically possible, because then the stiffness of these spring elements would be infinite!
- The default setting for the penetration depth at contact is based on 5% of the square root of the contact area (value gained from experience).

## Introduction to the Penalty Method used in Mechanica (2)

### Achieving convergence of the nonlinear matrix equation $K(u,f) \cdot u = f$ in contact analysis using Newton-Raphson technique:

- Before convergence we can calculate the residual error corresponding to the latest solution of the displacement vector  $u$ :  $r = f - Ku$ . Here, the residual vector  $r$ , has the dimensions of force (this force must be zero for system convergence). The Newton-Raphson solution then solves for  $Kdu = r$  to determine the change in  $u$  in the next iteration.
- The residual norm is the dot product  $r \cdot du$ . It can be thought of physically as a residual energy, which should be zero when we're converged. We normalize the residual norm with the dot product of the total displacement and the total force vector, so the residual norm is:  $(r \cdot du) / (u \cdot f)$ .
- This residual norm must be smaller than the default value of  $1.0E-14$  to achieve convergence for the "Residual Norm Tolerance" in Mechanica.
- Further reading:  
Crisfield, M: Nonlinear Finite Element Analysis of Solids and Structures  
Wiley, 1991, p 254.

## Introduction to the Penalty Method used in Mechanics (3)

### Further information on the Newton-Raphson process in Mechanics:

- The iteration status is listed in the study \*.pas file, the \*.rpt and \*.stt files do not give this information!
- Typically an iteration process can be seen as follows:

| Iteration | Residual norm                                      | Area        |                  |          |
|-----------|--|-------------|------------------|----------|
|           | Load factor  | 1.00000e+00 |                  |          |
|           | Residual norm tolerance:                           | 1.00000e-14 |                  |          |
| 1         | 1.00000e+00  | 7.9794e+02  | Sun Nov 11, 2007 | 15:34:36 |
| 2         | 5.4967e-01   | 7.9794e+02  | Sun Nov 11, 2007 | 15:34:36 |
| 3         | 9.5526e-01   | 7.9794e+02  | Sun Nov 11, 2007 | 15:34:36 |
| 4         | 9.1701e-01   | 7.9794e+02  | Sun Nov 11, 2007 | 15:34:36 |
| 5         | 1.00000e+00  | 7.9794e+02  | Sun Nov 11, 2007 | 15:34:37 |
| 6         | 8.8052e-01   | 7.9794e+02  | Sun Nov 11, 2007 | 15:34:37 |
| 7         | 5.0490e-01   | 7.9794e+02  | Sun Nov 11, 2007 | 15:34:37 |
| 8         | 7.2459e-01   | 7.9794e+02  | Sun Nov 11, 2007 | 15:34:37 |
| 9         | 6.0253e-01   | 7.9794e+02  | Sun Nov 11, 2007 | 15:34:38 |
| 10        | 2.4577e-01   | 7.9794e+02  | Sun Nov 11, 2007 | 15:34:38 |
| 11        | 2.6957e-01   | 7.9794e+02  | Sun Nov 11, 2007 | 15:34:38 |
| 12        | 2.4156e-01   | 7.9794e+02  | Sun Nov 11, 2007 | 15:34:38 |
| 13        | 2.2617e-01   | 7.9794e+02  | Sun Nov 11, 2007 | 15:34:39 |
| 14        | 9.0905e-01   | 7.9794e+02  | Sun Nov 11, 2007 | 15:34:39 |
| 15        | 2.7626e-01   | 7.9794e+02  | Sun Nov 11, 2007 | 15:34:39 |
| 16        | 4.9702e-01   | 7.9794e+02  | Sun Nov 11, 2007 | 15:34:39 |
| 17        | 3.3956e-01   | 7.9794e+02  | Sun Nov 11, 2007 | 15:34:40 |
| 18        | 2.5672e-01   | 7.9794e+02  | Sun Nov 11, 2007 | 15:34:40 |
| 19        | 3.2118e-01   | 7.9794e+02  | Sun Nov 11, 2007 | 15:34:40 |
| 20        | 3.1372e-01   | 7.9794e+02  | Sun Nov 11, 2007 | 15:34:40 |
| 21        | 4.7649e-01   | 7.9794e+02  | Sun Nov 11, 2007 | 15:34:41 |
| 22        | 3.9611e-01   | 7.9794e+02  | Sun Nov 11, 2007 | 15:34:41 |
|           | Loosening gap stiffness to improve convergence     |             |                  |          |
| 23        | 1.0000e+00   | 7.9794e+02  | Sun Nov 11, 2007 | 15:34:41 |
| 24        | 4.6502e-06   | 7.9855e+02  | Sun Nov 11, 2007 | 15:34:41 |
| 25        | 1.3372e-26   | 7.9855e+02  | Sun Nov 11, 2007 | 15:34:42 |
|           | Adjusted gap stiffness to prevent interpenetration |             |                  |          |
| 26        | 1.0000e+00   | 7.9855e+02  | Sun Nov 11, 2007 | 15:34:42 |
| 27        | 2.2000e-26   | 7.9855e+02  | Sun Nov 11, 2007 | 15:34:42 |
|           | Adjusted gap stiffness to prevent interpenetration |             |                  |          |
| 28        | 7.7816e-03   | 7.9855e+02  | Sun Nov 11, 2007 | 15:34:42 |
| 29        | 7.7392e-09   | 7.9675e+02  | Sun Nov 11, 2007 | 15:34:43 |
| 30        | 9.9023e-27   | 7.9675e+02  | Sun Nov 11, 2007 | 15:34:43 |

Tolerance for the allowed residual norm  $(r \cdot du)/(u \cdot f)$

Listing of the current residual norm and the sum of all contact surfaces in each step

Mechanica automatically reduces the stiffness of the contact gap-spring elements to improve the convergence of the matrix equation  $K \cdot u = f$

If necessary Mechanica independently increases the stiffness of the contact spring elements to reduce the penetration at the contact edges

## Introduction to the Penalty Method used in Mechanica (4)

### Technical software implementation of Mechanica contact analysis :

- In a contact analysis, each calculation pass (for both Single-Pass or Multi-Pass convergence analysis) is performed in at least two load steps:
  - A “load step 0” without external load (no load set is active, only the boundary condition set): When initial penetration at a contact edge due to press fit is recognized and can be calculated
  - A “load step 1” with all external loads in the selected load set at the same time, building on the converged system from load step 0!
  - In addition, you can optionally define interim load intervals, where all loads are scaled in sync (not recommended for models with press fits)
- An interference ( “press fit”) can be achieved either by an actual interference in the Pro/E model or by using a thermal load (with modified coefficient of linear expansion), however in extreme cases, since the software solution process is different for both methods, depending on the problem different results may be obtained!
- Here you can see the \*.rpt file information, as shown in the following slide:

## Introduction to the Penalty Method used in Mechanics (5)

### Technical software implementation of Mechanics contact analysis :

- Example without interference:

```
Convergence Loop Log:
>> Pass 1 <<
  Calculating Element Equations
    Total Number of Equations:    2438
    Maximum Edge Order:           1
  Solving Equations
  Load Increment 0 of 1
  Load Factor: 0.00000e+00
  Contact Area: 0.00000e+00
  Calculating Disp and Stress Results
  Load Increment 1 of 1
  Load Factor: 1.00000e+00
  Contact Area: 7.84949e+02
  Calculating Disp and Stress Results
```

In load increment 0 the contact area is zero in the case without external load and without press fit, the contact first occurs in increment 1 under external load (in this case a temperature load makes a shrinkage effect)

- Example with interference:

```
Convergence Loop Log:
>> Pass 1 <<
  Calculating Element Equations
    Total Number of Equations:    2438
    Maximum Edge Order:           1
  Solving Equations
  Load Increment 0 of 1
  Load Factor: 0.00000e+00
  Contact Area: 7.84523e+02
  The contact area is non-zero for zero load
  factor because there is initial interpenetration
  (interference fit) in at least one contact
  region.
  Calculating Disp and Stress Results
  Load Increment 1 of 1
  Load Factor: 1.00000e+00
  Contact Area: 7.84949e+02
  Calculating Disp and Stress Results
```

In this case contact is non-zero in load increment 0 without external load, due to an interference fit in the Pro/ENGINEER model



## Introduction to the Penalty Method used in Mechanics (6)

### Technical software implementation of Mechanics contact analysis :

- In extreme cases this can lead to different results:

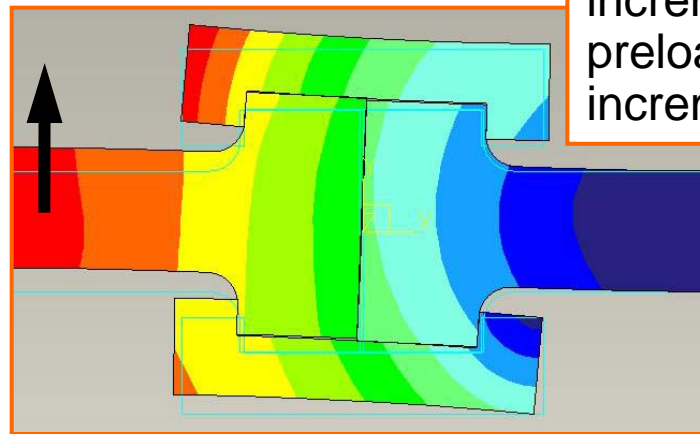

Example from Rich King,  
Mechanica Development

With an interference fit in the model the transverse load is correctly combined in increment 1 with the already preloaded system in load increment 0

In the case of an interference fit in the model due to temperature load the combination of transverse load only occurs in increment 1, and in this case an undesired deformation and stress has occurred

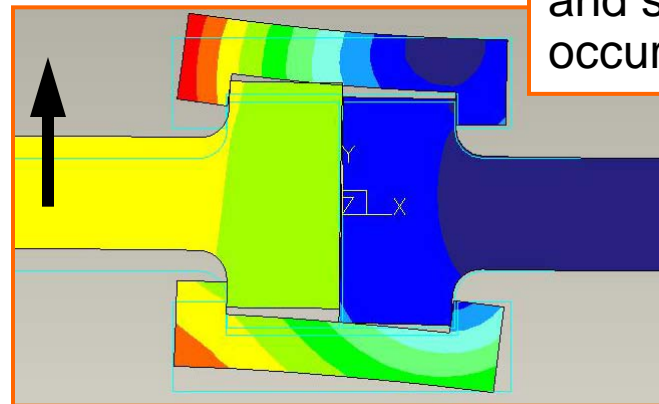

## Introduction to the Penalty Method used in Mechanics (7)

### Contact measures

- For every contact the following measures are available:
  - Force: \*)  
Contact force is calculated from the resulting spring force of the gap elements
  - Load:  
Contact load is calculated from the integral of the contact pressure over the contact area  
→ As a quality check of the results it's a good idea to compare the load/force
  - Area: \*)  
Contact area
  - Maximum contact pressure
  - Average contact pressure:  
corresponds to the load divided by the contact area (not force/contact area)
- Note:  
There are additional measures available for contact regions with infinite friction, which will be referred to later

## Contact Analysis with Infinite Friction Functionality (1)

### Contact with infinite friction

- On selection of contact with friction with closed contact surfaces, any large shear load can be accommodated (independent of the magnitude of the pressure load) without sliding occurring

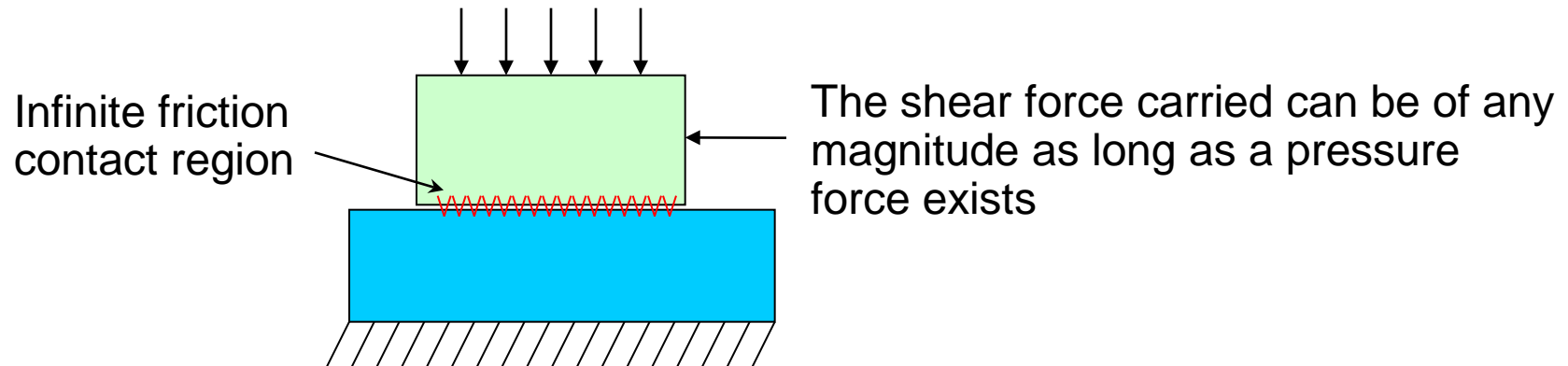

- After the analysis has run, it is therefore important to check whether the model is still valid or whether under a shear load a slip would occur between the contact surfaces because the friction resistance force ( $= \text{pressure load} \times \text{friction coefficient}$ ) is too low.

## Contact Analysis with Infinite Friction Functionality (2)

### The definition of „Slippage“ in a contact with friction analysis

- Consider an arbitrary point  $x_i$  on the edge of the contact with its local normal vector  $n$  and the local „Traction Vector“  $t$ :

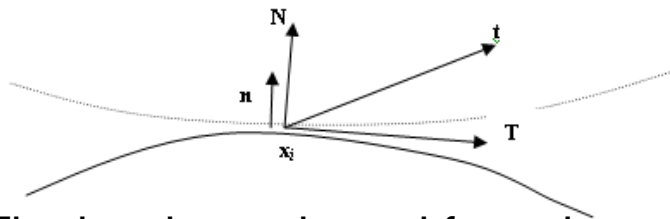

- The local area based force is now  $N$  (with the units of pressure = force/area), the local area based shear force is  $T$  („Tangential Traction“).  $T$  has the units of shear stress = force/area.
- Slippage at the point  $x_i$  does not occur (because of the general law of friction  $F_R \leq \mu \cdot F_N$ ), as long as the locally occurring area-based shear force  $T$  is less than the product of area based contact force  $N$  and Coefficient of Friction  $\mu$ :

$$S_i = T - \mu \cdot N \leq 0$$

- The value of the "slippage"  $S_i$  can be seen as being very helpful for checking the validity of the contact analysis: It must be  $\leq 0$  for a valid model

## Contact Analysis with Infinite Friction Functionality (3)

### Measures to verify the validity of the contact model

- The „Slippage“  $S_i$  is in general unevenly distributed over the contact area, therefore its characteristic values are made available in the form of three different measurements. Mechanica automatically puts these in the rpt file for true friction contacts, as long as an actual coefficient of friction is specified in the UI:
  - InterfaceName\_any\_slippage:  
(better read as „maximum slippage  $S_{imax}$  found in the contact region“)
  - InterfaceName\_complete\_slippage:  
(better read as „minimum slippage  $S_{imin}$  found in the contact region“)
  - InterfaceName\_average\_slippage:  
(„average slippage  $S_{iav}$  found in the contact region“)
  - Additionally the measure InterfaceName\_max\_tang\_traction is provided  
(better read as „maximum contact shear stress in the contact region“)
- The characteristic values for the „Slippage“ and the „Tang Traction“ can be found not only in the rpt file, but also their complete distribution over the entire contact surface can be seen in the post-processor results

## Tips, for when nothing else works...

### What to do if a contact analysis doesn't give a meaningful result?

- Experienced users can use different „Engine Command Line“ options or environment variables to influence the non-linear iteration:
  - To control the maximum allowed penetration of the contact surfaces:  
 Engine command line option: `-contact_penetration N`  
 N is the multiplication factor for the max. allowed penetration depth. The default penetration depth is 0.05 (=5% of the square root value of the contact area). If you set N to 0.01 for example, the maximum penetration depth is reduced to 0.0005 (=0.05% of the square root value of the contact area).
  - To change the maximum allowed number of iterations per load step  
 Engine command line option: `-contact_nr_its M`  
 M is the allowed number of iterations per load step, until the system stops, if no convergence has been reached. The default is 200 steps (see the \*.pas file).
  - To change the „Residual Norm Tolerance“:  
 Environment variable: `MSE_CONTACT_TOLERANCE_FACTOR y`  
 The default tolerance is 1.0E-14. The environment variable y acts as multiplication factor to the default value. For example if you set y to 1.0E6, the residual norm tolerance is increased to 1.E-08.

## Application Examples of Typical Industrial Components

- Rolling load in a cylindrical roller bearing (friction free Hertzian contact)
- Torque transmission in a shaft-hub connection with shrink fit

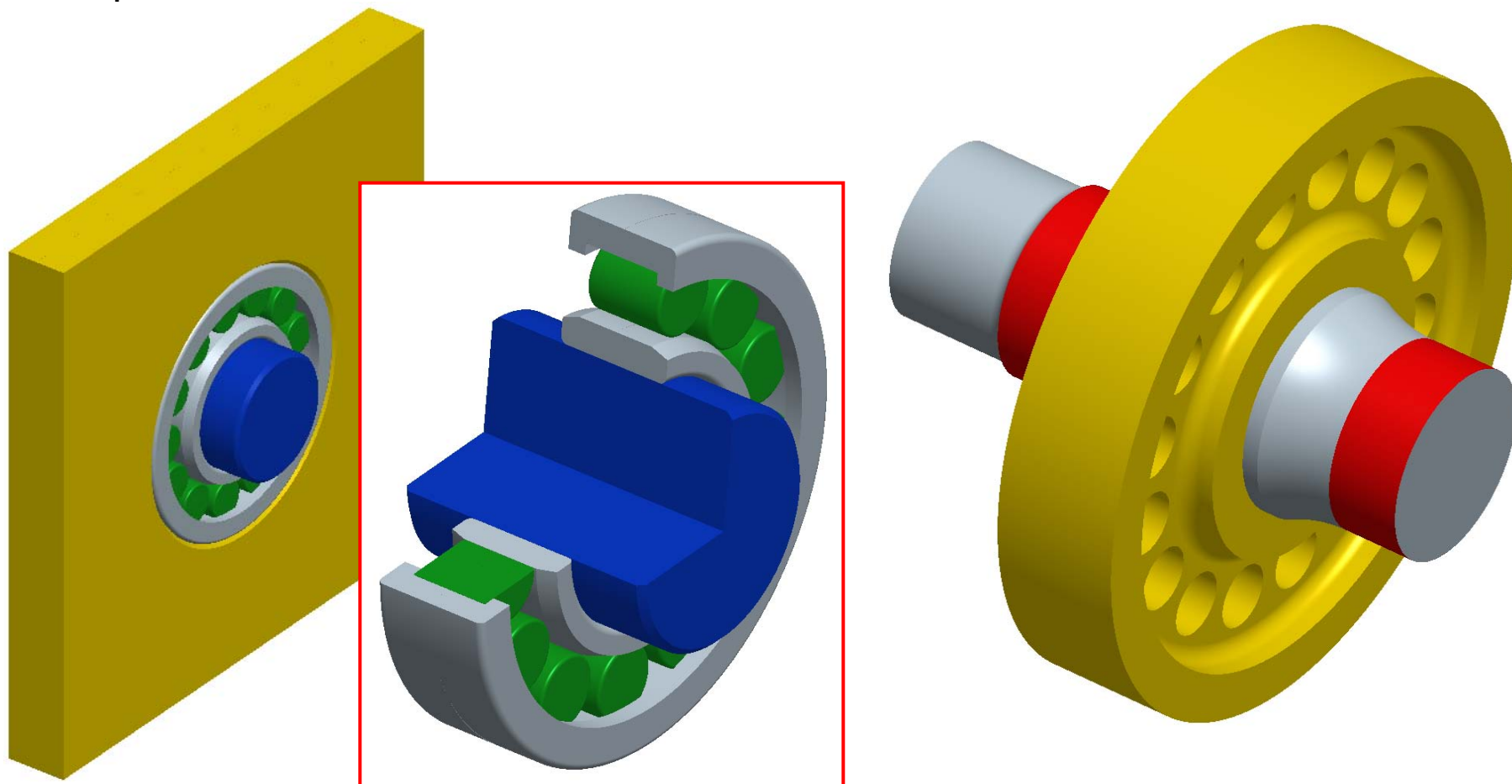

## Rolling Load in a Cylindrical Roller Bearing (1)

### Details of the Models

- FAG-Cylindrical Roller Bearing NU314E, Load Rating  $C_0=220$  kN
- Shaft diameter 70 mm  
Housing diameter 150 mm  
Bearing width 35 mm  
Bearing inner ring outside diameter 89 mm  
Bearing outer ring inside diameter 133 mm  
Roller length 24 mm, load carrying 22 mm  
Roller diameter: 22 mm  
(13 rollers)
- Bearing and shaft material: Steel  
 $E=210000$  MPa;  $\nu=0,3$
- Housing material: Alu  
 $E=70000$  MPa;  $\nu=0,3$   
(alternatively also in Steel)
- Contact without friction

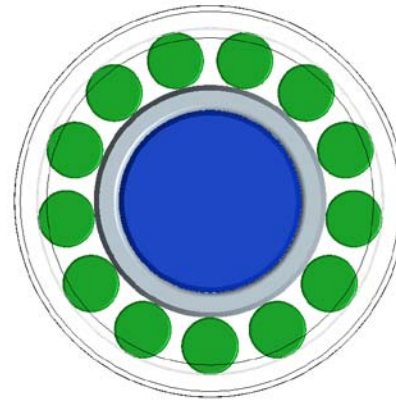

Dr. Hans-Jürgen Böhmer  
(Schaeffler KG) must be thanked  
very much for the information and  
the discussions

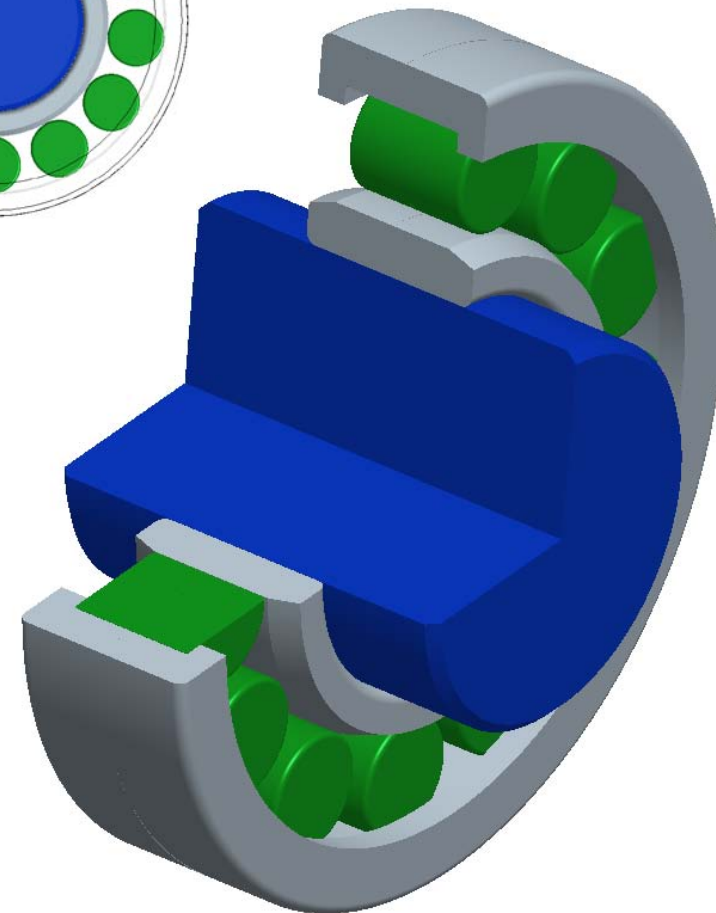



## Rolling Load in a Cylindrical Roller Bearing (2)

### Background information

- The FAG roller bearing catalogue states that the contact pressure at the maximum stress position between rolling elements and race reaches 4000 MPa on reaching the static load rating  $C_0$  (for this bearing 220000 N). This is a notional value, calculated through the application of Hertzian contact theory assuming linear-elastic material.
- In reality when the bearing is subject to a load  $C_0$  a permanent plastic deformation would occur in the middle of the contact surfaces of the highest loaded roller and race of approximately 1/10000 the roller diameter. Due to high demands for positional accuracy required of the bearing, it should not be loaded as high as  $C_0$ , for dynamic loading the bearing load must be much lower.
- There is no catalogue information advising what material the housing and shaft should be or what fit and bearing play were used as a basis for the 4000 MPa value. For the following studies, these values only serve as guidance to what stresses are to be expected in the rolling elements and the bearing races at various adopted extreme tolerances.

## Rolling Load in a Cylindrical Roller Bearing (3)

### Choice of limits and fit in the model

- To calculate the influence from fitting tolerances to the bearing loading, the model will be analyzed with different extreme clearances:
  - A variant with minimum clearance:
    - Clearance to housing and shaft: 10  $\mu\text{m}$
    - Bearing clearance also 10  $\mu\text{m}$ ; this means, each rolling element is 5  $\mu\text{m}$  smaller than the half diameter difference between inner- and outer race ring of 22 mm (for this bearing size, this is equivalent to the minimum clearance of a high precise C1NA- clearance group bearing)
  - A variant with maximum clearance:
    - Clearance to housing and shaft : 100  $\mu\text{m}$
    - Bearing clearance 160  $\mu\text{m}$ , this means, each rolling element is 80  $\mu\text{m}$  smaller than the half diameter difference between inner- and outer race ring of 22 mm (for this bearing size, this is equivalent to the maximum clearance of a C5-clearance group bearing with increased play)  
Hint: „Normal“ group C0-bearings of this size have 40-75  $\mu\text{m}$  clearance
    - In addition, for the latter variant the soft Aluminum housing will be replaced by a stiffer steel housing, which should lead to higher contact pressures because of a more worse osculation

## Rolling Load in a Cylindrical Roller Bearing (4)

### Choice of the external load direction

- For all variants the load vector is applied in a way, that six or seven rolling elements are within the loaded half of the bearing

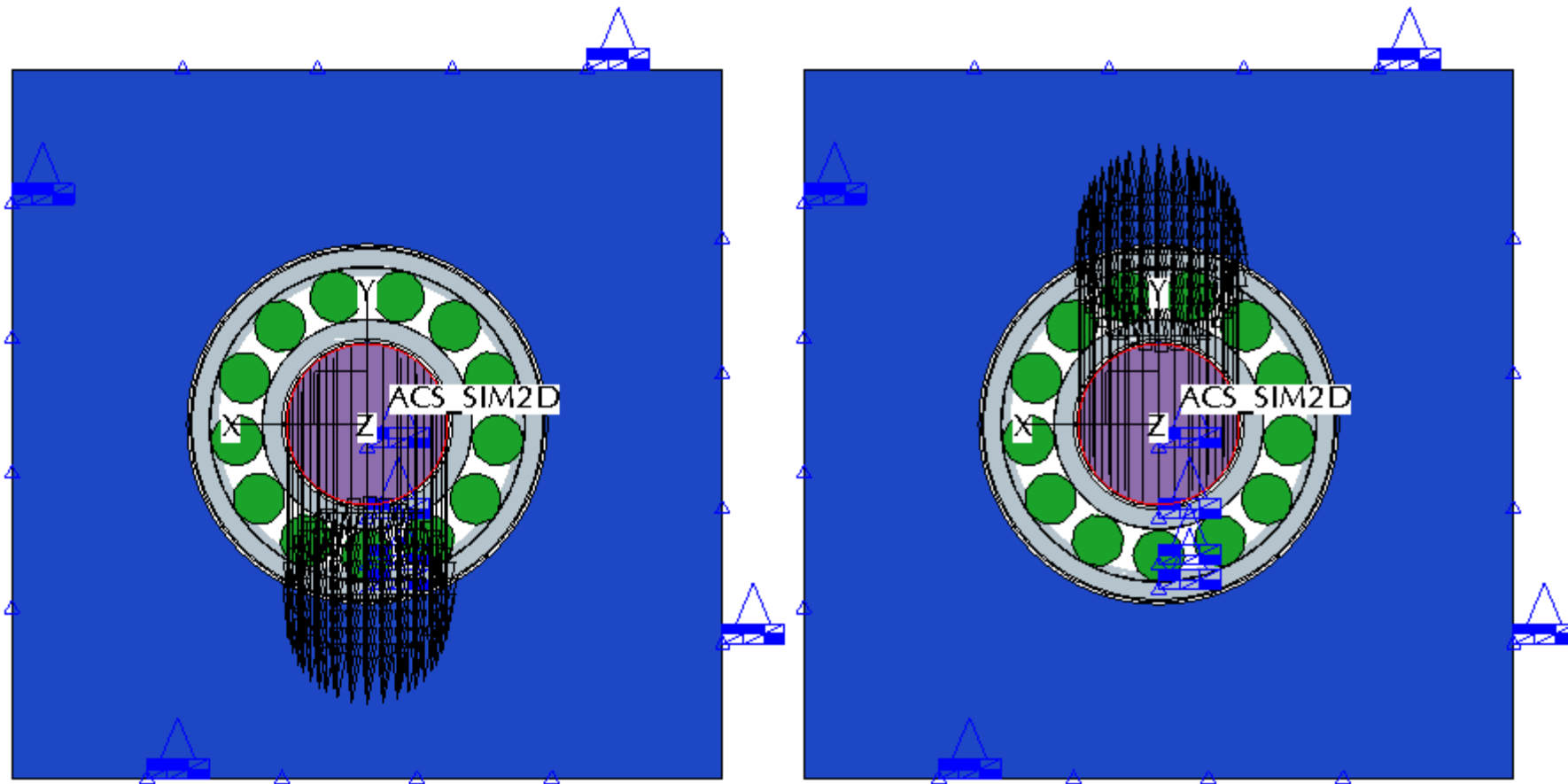

## Rolling Load in a Cylindrical Roller Bearing (5)

### Idealization

- The idealization of the bearing assembly is difficult, since the Hertzian stress state within a rolling body – having the maximum comparative (shear) stress below the contact surface – is created by preventing of the axial transverse strain. Therefore, here the plane stress state cannot be used.
- In opposite, the „housing plate“ – outside the bearing load introduction – is just loaded in its plane, so here the plane stress condition would be fine for idealization
- Since here just the bearing loads are of interest, the plane strain condition will be selected

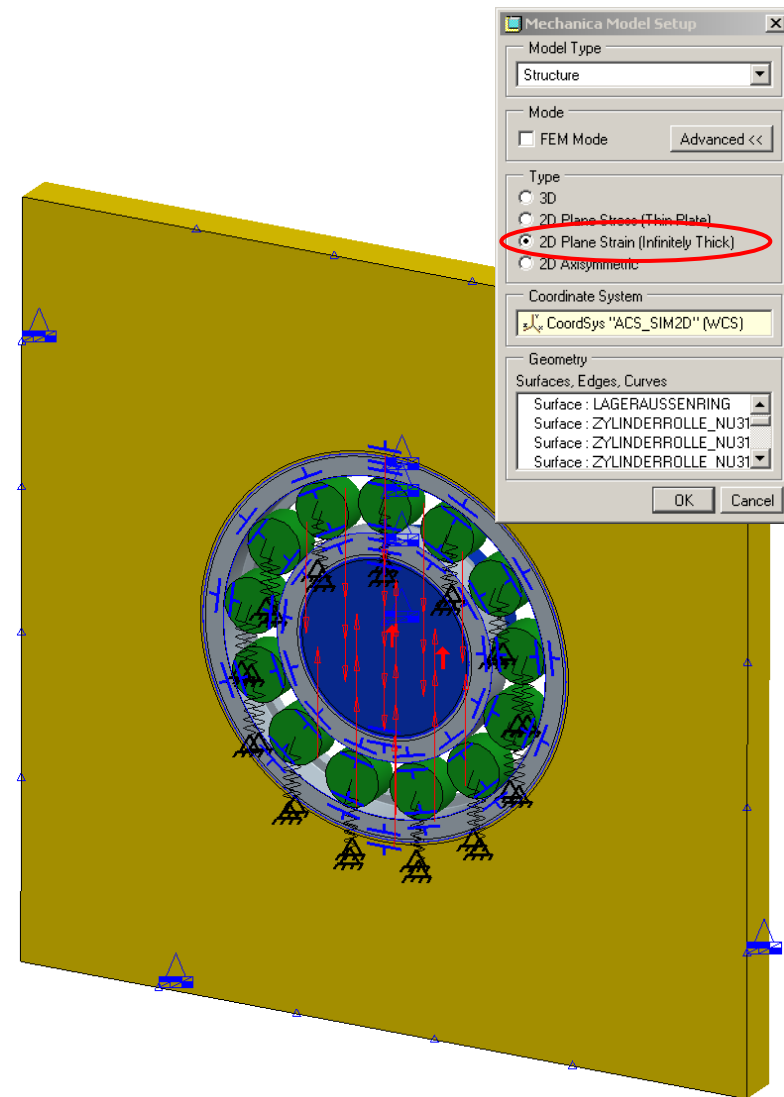

# Rolling Load in a Cylindrical Roller Bearing (6)

- Ensuring the result quality through improved (refined) meshing and creation of contact specific measures

The image displays a CAD simulation environment for a cylindrical roller bearing. On the left, a tree view lists simulation features including Loads/Constraints, Material Assignments, and a list of 30 interfaces. The main view shows a 3D model of the bearing with a green mesh. A 'Model Summary' dialog box is open, providing the following data:

| Property                 | Value |
|--------------------------|-------|
| Number of Mass Elements: | 0     |
| Number of Springs:       | 26    |
| Number of 2D Shells:     | 0     |
| Number of 2D Solids:     | 13492 |
| Number of Links:         | 0     |
| Number of Contacts:      | 30    |
| Number of Rigid Links:   | 0     |

The dialog box also includes a 'Close' button. A red box in the main view highlights a specific contact area between the rollers and the inner ring, which is magnified in the inset view on the left.

## Rolling Load in a Cylindrical Roller Bearing (7)

### Additional convergence consideration

- To reach very accurate Hertz contact pressures, in general the described intervention into the allowed contact penetration depth may be necessary
- This will be done exemplary for the analysis with a minimum clearance and 7 roller elements in contact. Standard penetration and 4 additional penetration settings are used, in which the allowed penetration will be reduced by a potency of ten, respectively
- Shown as a function of the allowed penetration depth: Maximum contact pressure, maximum von Mises-stress, CPU-time, total analysis time (4-processor computer DELL Precision 690, Windows XP 64 bit).  
Hint: Since parallel processes have been run on the same computer, especially the total analysis time are just an approximate guiding value!
- As shown in the graphs on the next slide, the results are stable from a penetration reduction factor of 100, but the total analysis time then further increases since convergence is now more difficult to achieve. Therefore, all subsequent analyses are done with „-contact\_penetration 0.01“ as (in this example!) ideal contact penetration setting!

# Rolling Load in a Cylindrical Roller Bearing (8)

## Influence of the contact penetration setting

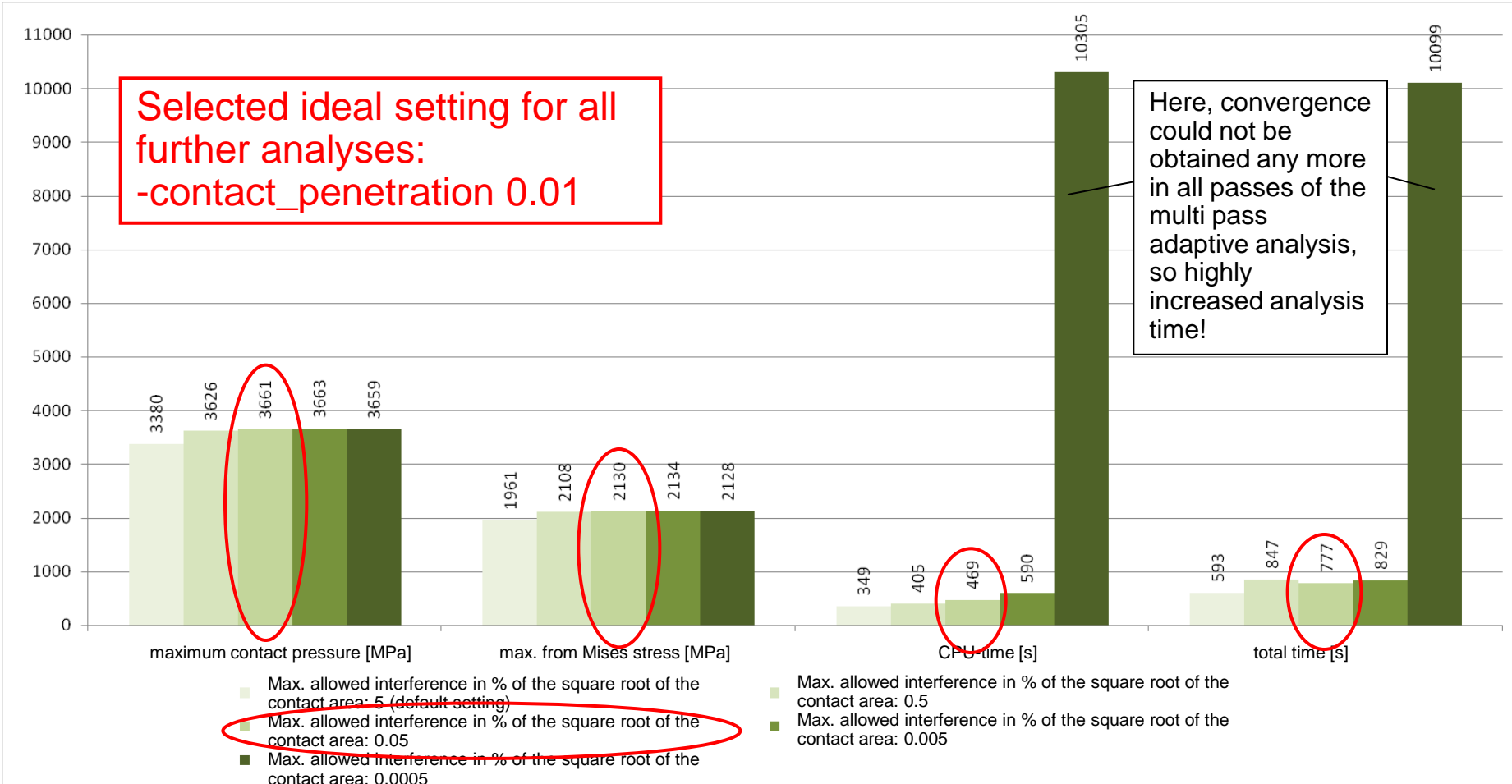

# Rolling Load in a Cylindrical Roller Bearing (9)

## Influence of the clearances and the housing material

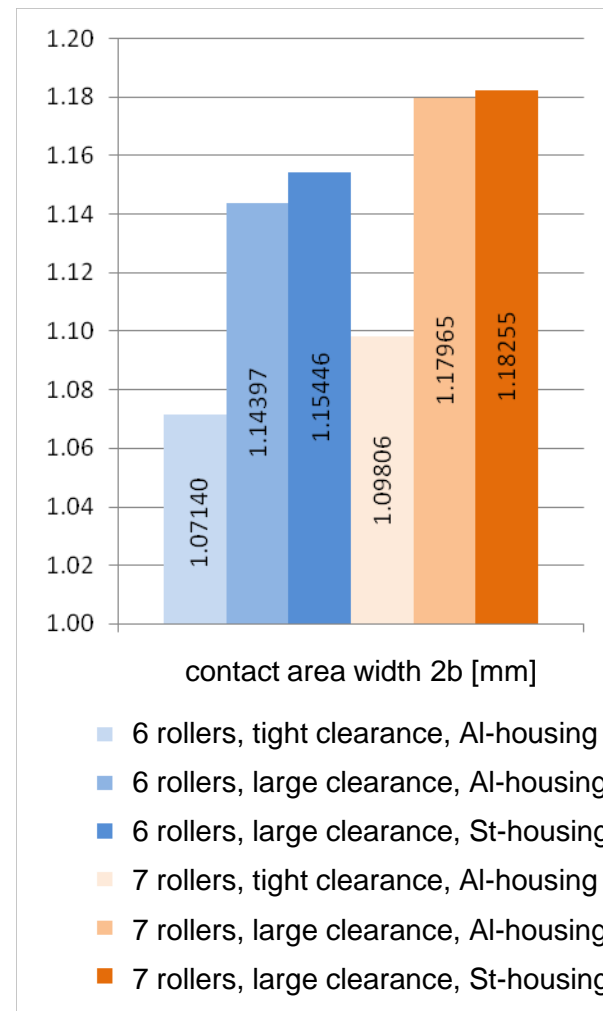
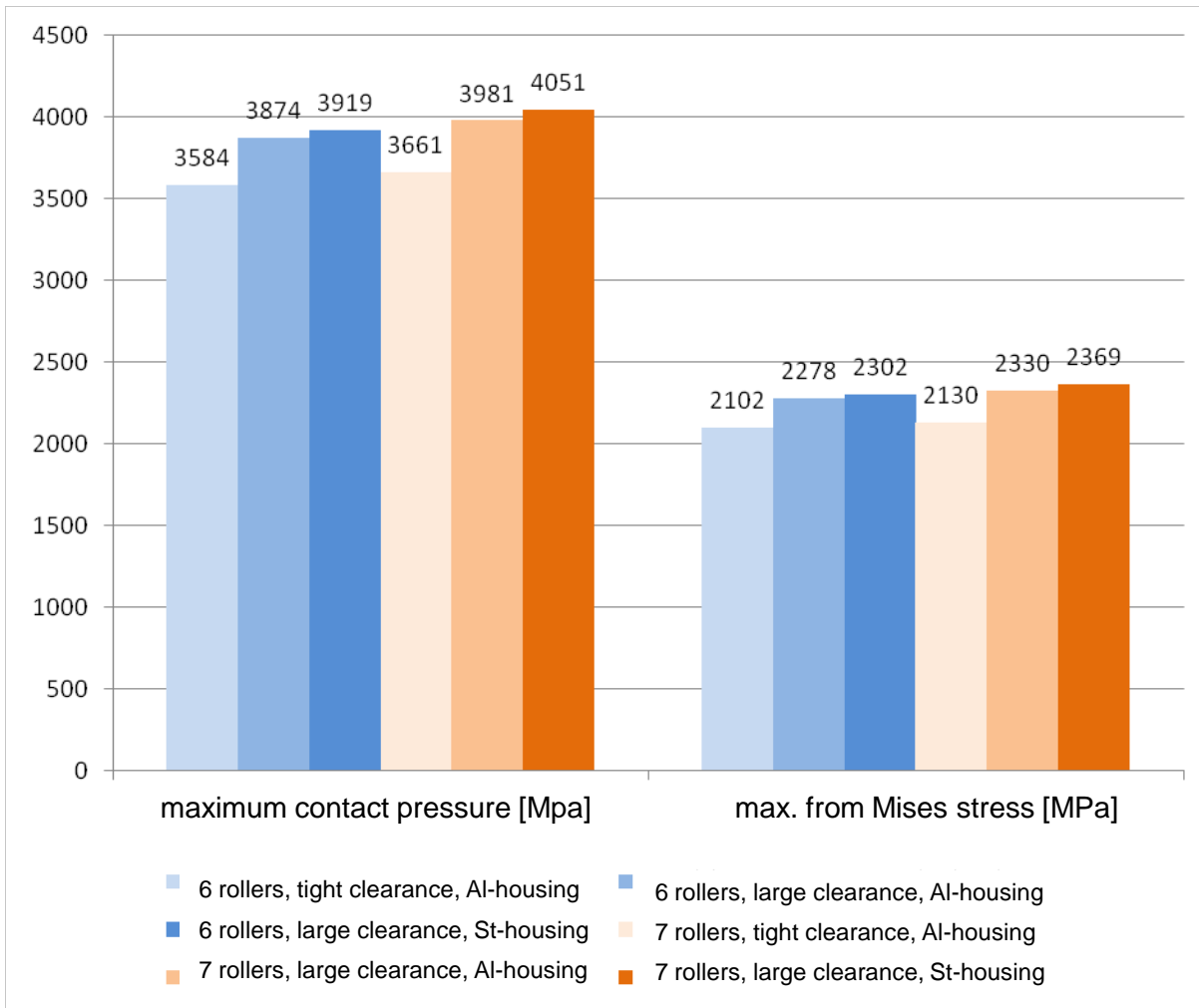



# Rolling Load in a Cylindrical Roller Bearing (10)

## Force distribution over the roller bodies at 220 kN bearing load

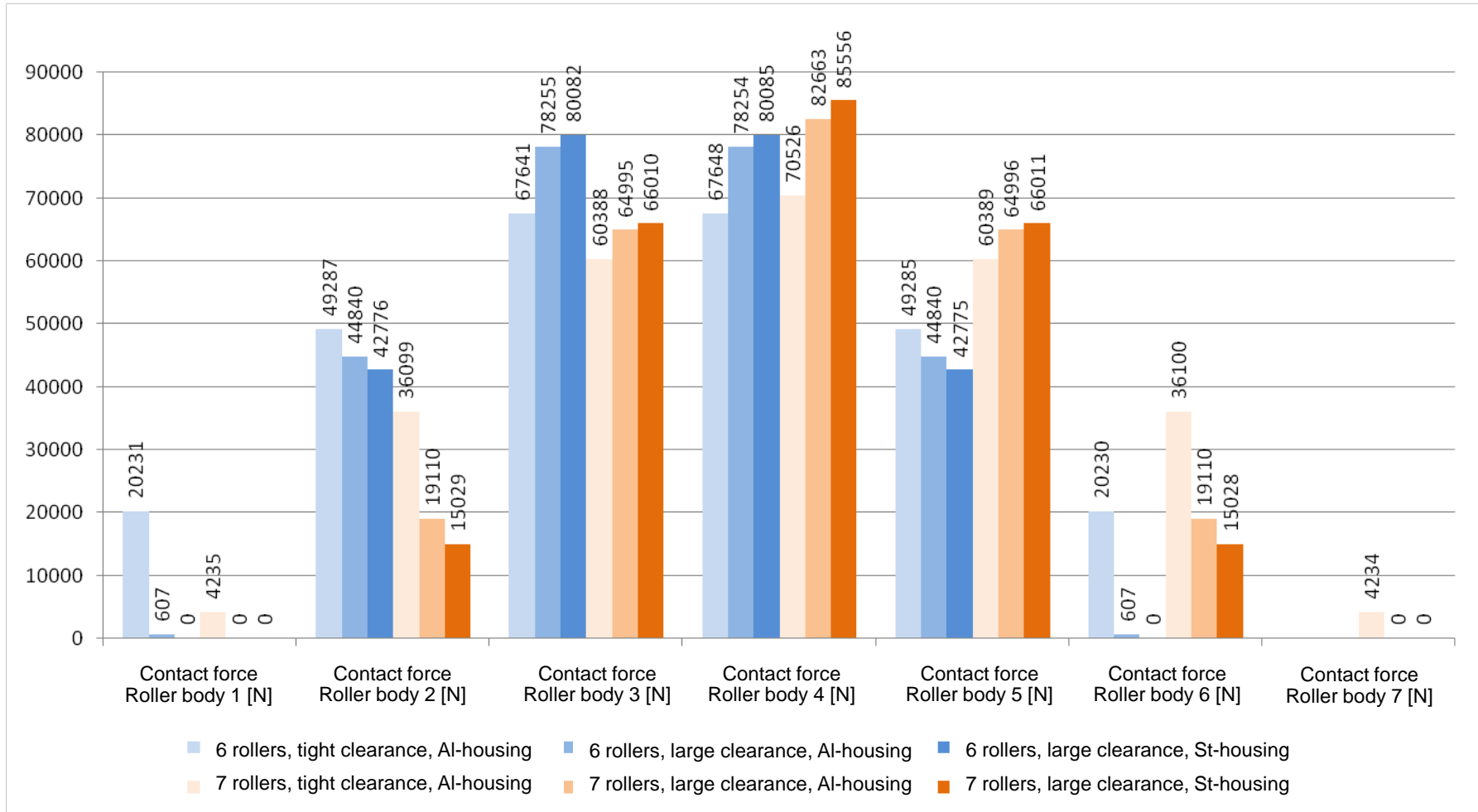

# Rolling Load in a Cylindrical Roller Bearing (11)

## Analytical comparison computation, exemplary for the highest loaded roller element with 85,556 kN contact force (Mathcad)

### 1. Geometrievorgaben:

Zylinderradius Wälzkörper:  $r_1 := \frac{21.92}{2} \text{ mm}$

Zylinderradius Lagerinnenring:  $r_2 := \frac{89}{2} \text{ mm}$

Ersatzradius:  $r := \frac{1}{\left(\frac{1}{r_1} + \frac{1}{r_2}\right)} = 8.79409 \text{ mm}$

Kontaktlänge:  $l_0 := 22 \text{ mm}$

### 2. Materialvorgaben:

E-Modul Stahl:  $E_1 := 210000 \text{ MPa}$

Querdehnzahl Stahl:  $\nu_1 := 0.3$

### 3. Druckkrafteergebniss am maximal beanspruchten Wälzkörper:

Druckkraft:  $F := 85556 \text{ N}$

### 4. Analytische Ergebnisse aus Hertzscher Theorie:

#### Ergebnisse an der Kontaktfläche:

Halbe Kontaktbreite:  $b_0 := \sqrt{\frac{8Fr \cdot (1 - \nu_1^2)}{\pi E_1 \cdot l_0}} = 0.614 \text{ mm}$

Kontaktfläche:  $A_0 := 2 \cdot b_0 \cdot l_0 = 27.03 \text{ mm}^2$

max. Kontaktdruck:  $p_{\text{maxo}} := \frac{2 \cdot F}{\pi \cdot b_0 \cdot l_0} = 4030.1 \text{ MPa}$

max. Vergleichsspannung:  $0.56 \cdot p_{\text{maxo}} = 2256.9 \text{ MPa}$

#### Zum Vergleich Mechanica-Ergebnisse:

Kontaktfläche: 26.02 mm<sup>2</sup> (Abweichung 3.9 %)

max. Kontaktdruck: 4051 MPa (Abweichung 0.5 %)

max. Vergleichsspannung: 2369 MPa (Abweichung 4.9 %)

#### **Hint:**

Mechanica analysis was done in multi pass adaptive convergence with 5 % on all measures!

## Rolling Load in a Cylindrical Roller Bearing (12)

---

### Result evaluation in the postprocessor

- Subsequently, for time reasons just some exemplary evaluations are shown (von Mises stress and contact pressure)
- Clear to see are the von Mises stress maxima below the contact surface, which would lead to pitting under repeated dynamic load
- These stress maxima – acc. to the Hertz' theory – are located from the surface in a depth of 0.7 times the half contact width  $b_0$  of the pressure ellipse, which is fulfilled in good approximation
- Different values for the contact pressure and different number of roller bodies in contact as function of clearance and housing material are obtained also very well

# Rolling Load in a Cylindrical Roller Bearing (13)

## Von Mises stress distribution (6 rollers, tight clearance, Al-housing)

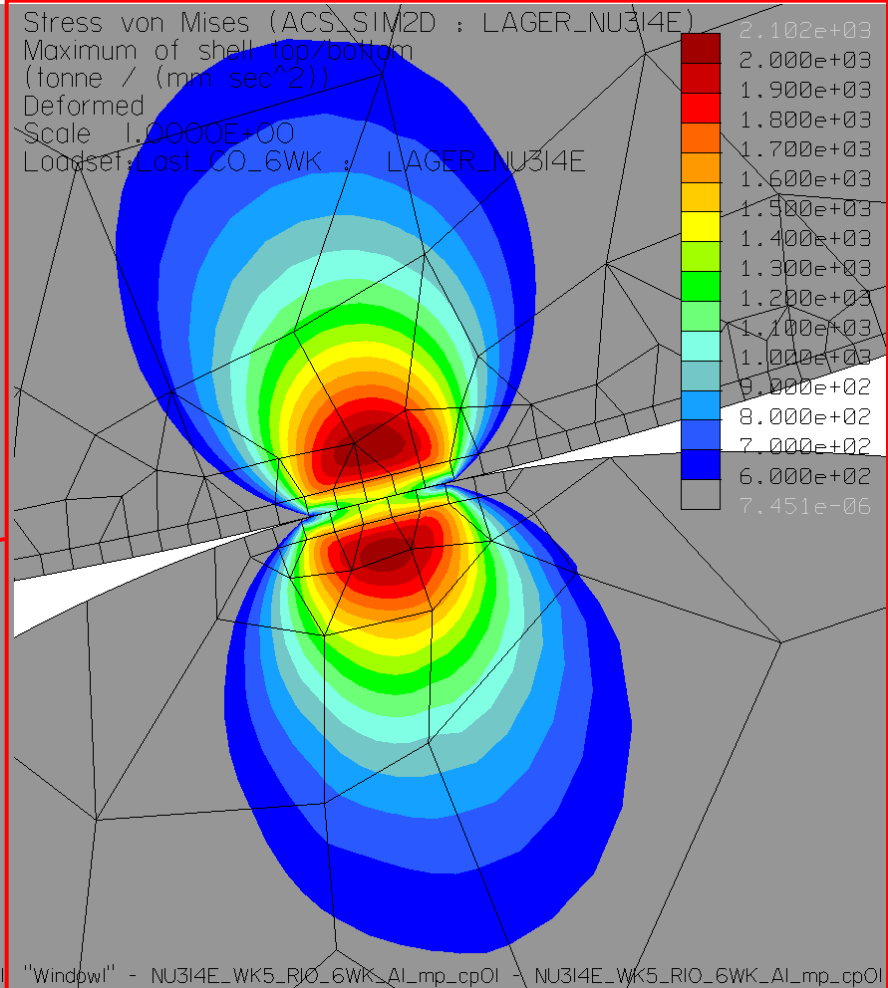
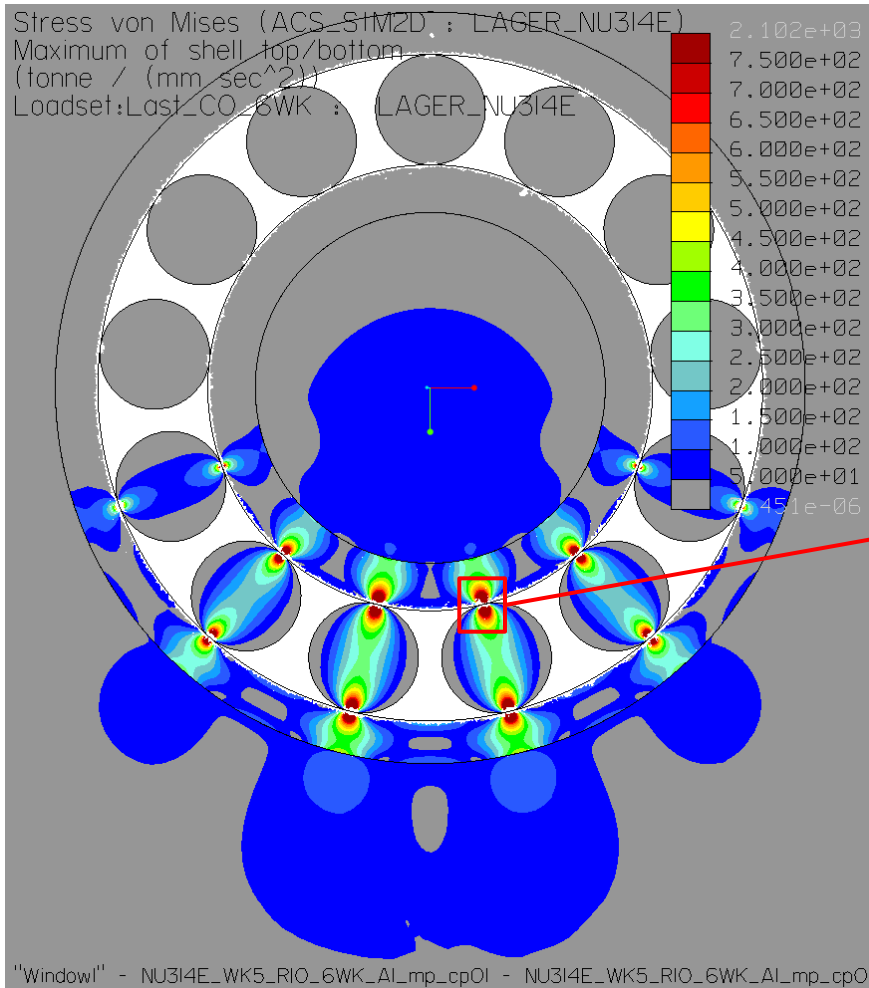

# Rolling Load in a Cylindrical Roller Bearing (14)

## Von Mises stress distribution (7 rollers, tight clearance, Al-housing)

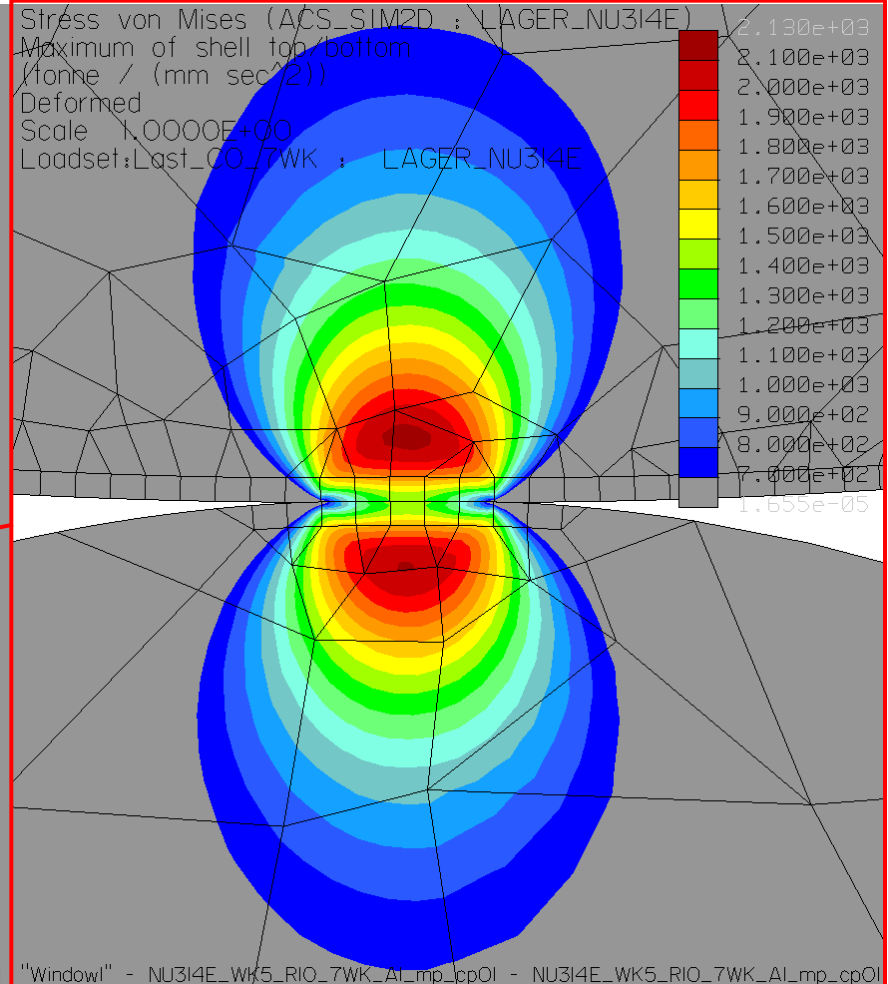
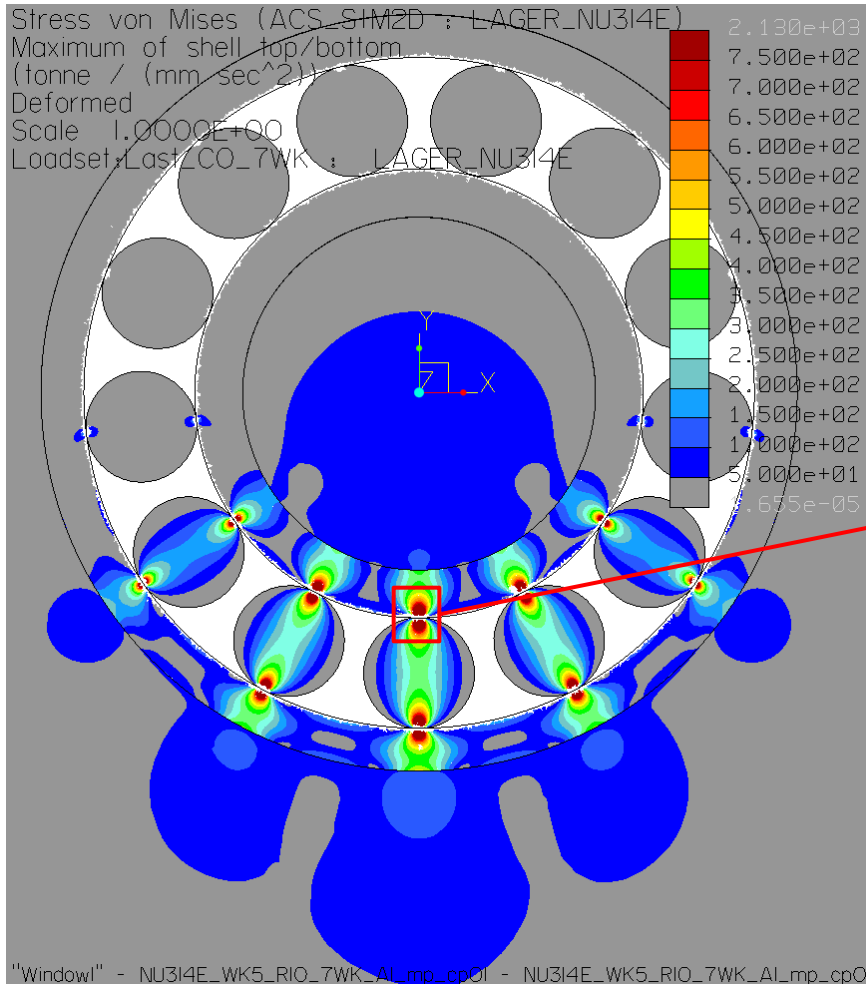

# Rolling Load in a Cylindrical Roller Bearing (15)

## Von Mises stress distribution (7 rollers, large clearance, St-housing)

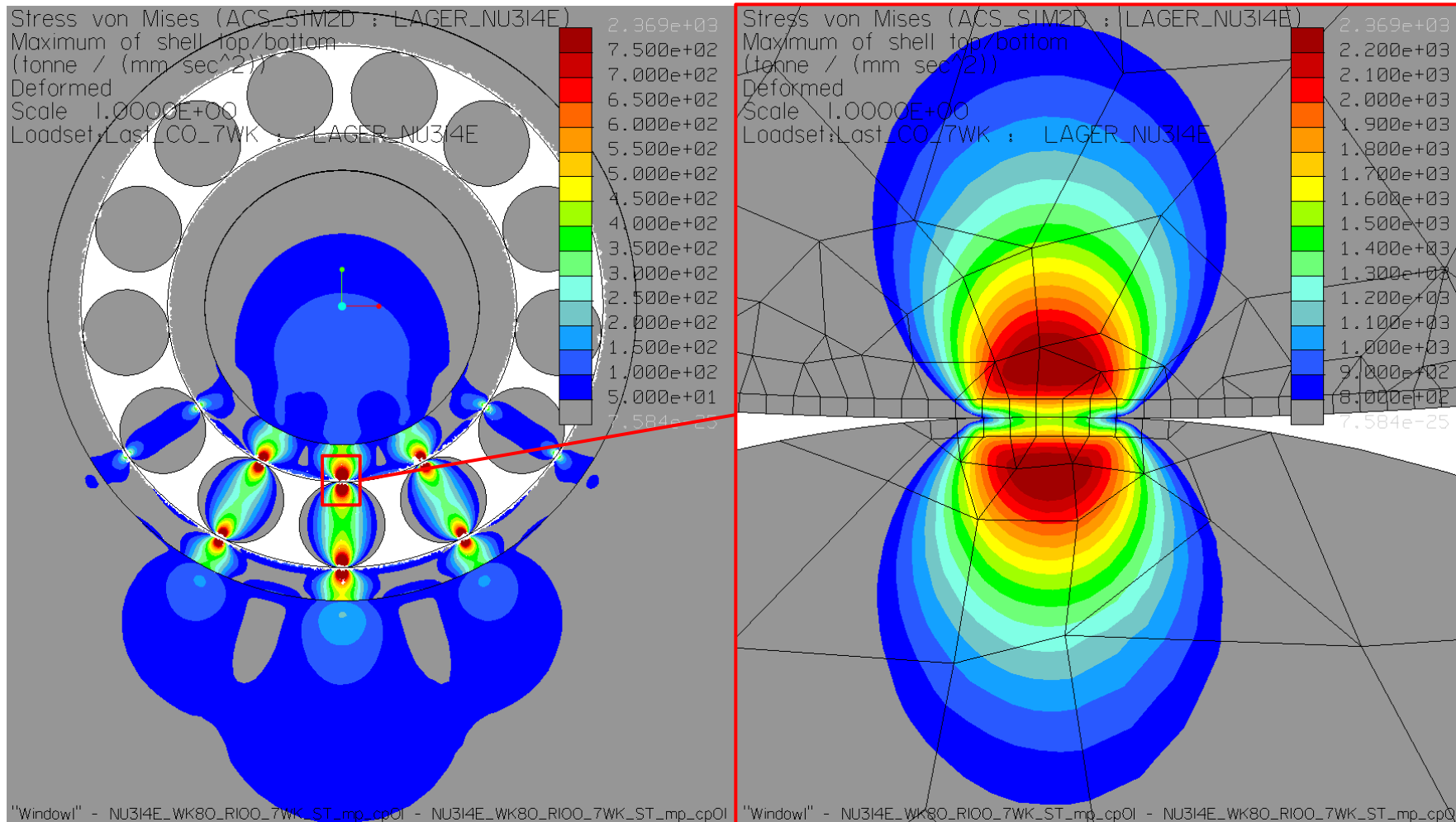

# Rolling Load in a Cylindrical Roller Bearing (16)

## Contact pressure distribution (6 rollers, tight clearance, Al-housing)

Contact Pressure (ACS\_SIM2D : LAGER\_NU314E)  
 (tonne / (mm sec<sup>2</sup>))  
 Curve  
 Loadset:Last\_C0\_6WK : LAGER\_NU314E

"Window1" - NU314E\_WK5\_R10\_6WK\_AI\_mp\_cp01 - NU314E\_WK5\_R10\_6WK\_AI\_mp\_cp01

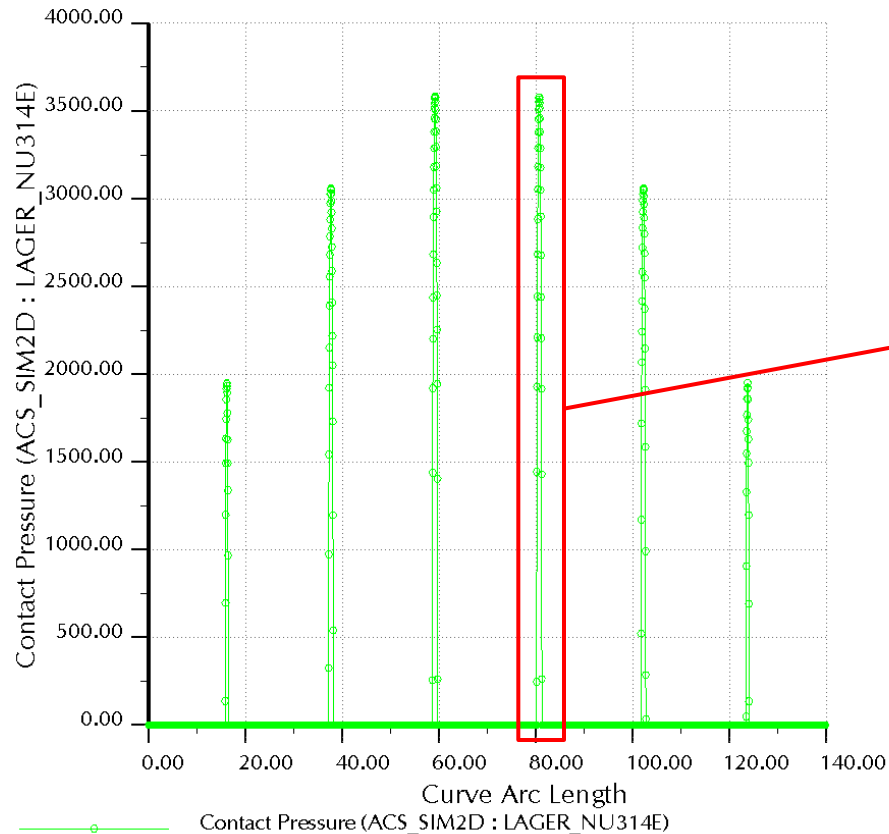

Contact Pressure (ACS\_SIM2D : LAGER\_NU314E)  
 (tonne / (mm sec<sup>2</sup>))  
 Curve  
 Loadset:Last\_C0\_6WK : LAGER\_NU314E

"Window1" - NU314E\_WK5\_R10\_6WK\_AI\_mp\_cp01 - NU314E\_WK5\_R10\_6WK\_AI\_mp\_cp01

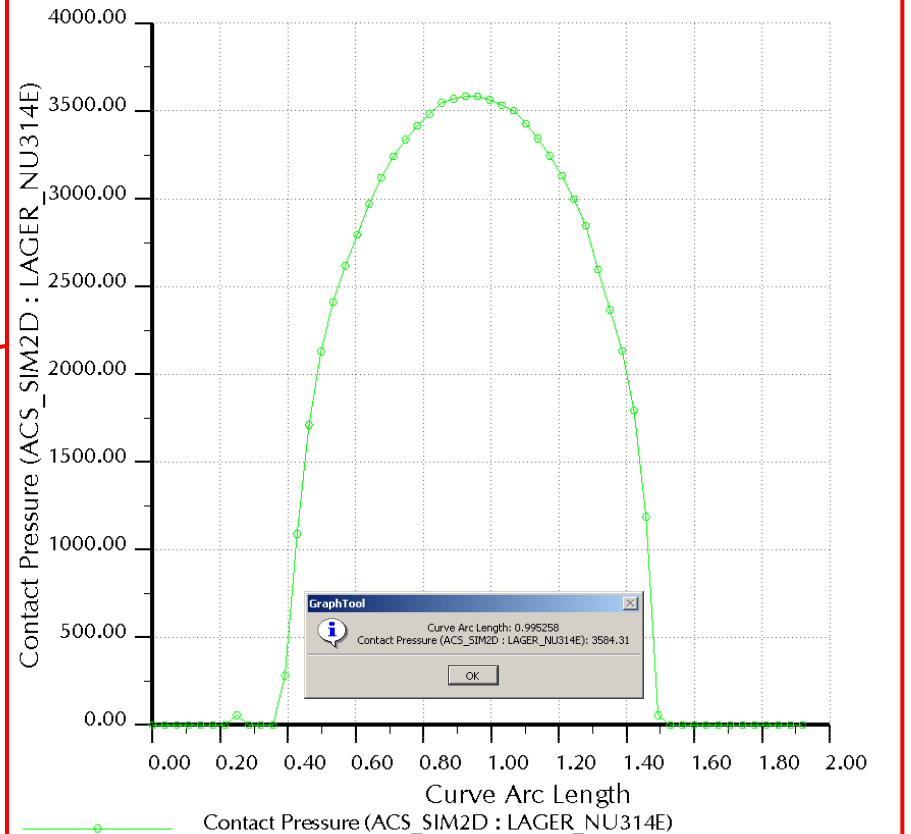

# Rolling Load in a Cylindrical Roller Bearing (17)

## Contact pressure distribution (7 rollers, tight clearance, Al-housing)

Contact Pressure (ACS\_SIM2D : LAGER\_NU314E)  
 (tonne / (mm sec<sup>2</sup>))  
 Curve  
 Loadset:Last\_C0\_7WK : LAGER\_NU314E

"Window1" - NU314E\_WK5\_R10\_7WK\_Al\_mp\_cp01 - NU314E\_WK5\_R10\_7WK\_Al\_mp\_cp01

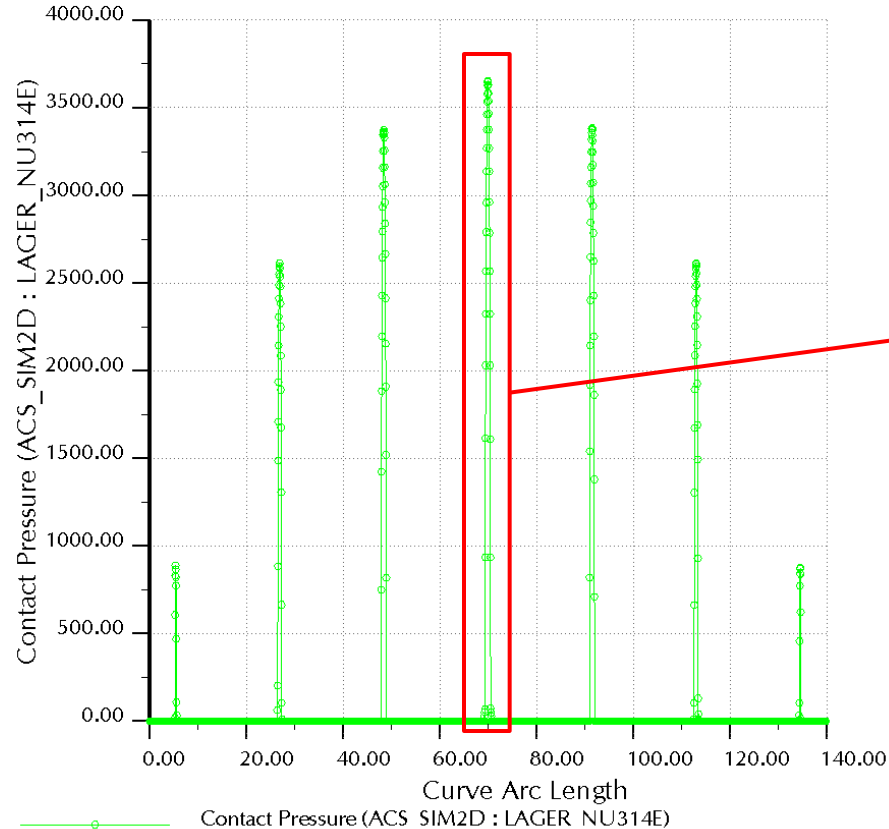

Contact Pressure (ACS\_SIM2D : LAGER\_NU314E)  
 (tonne / (mm sec<sup>2</sup>))  
 Curve  
 Loadset:Last\_C0\_7WK : LAGER\_NU314E

"Window1" - NU314E\_WK5\_R10\_7WK\_Al\_mp\_cp01 - NU314E\_WK5\_R10\_7WK\_Al\_mp\_cp01

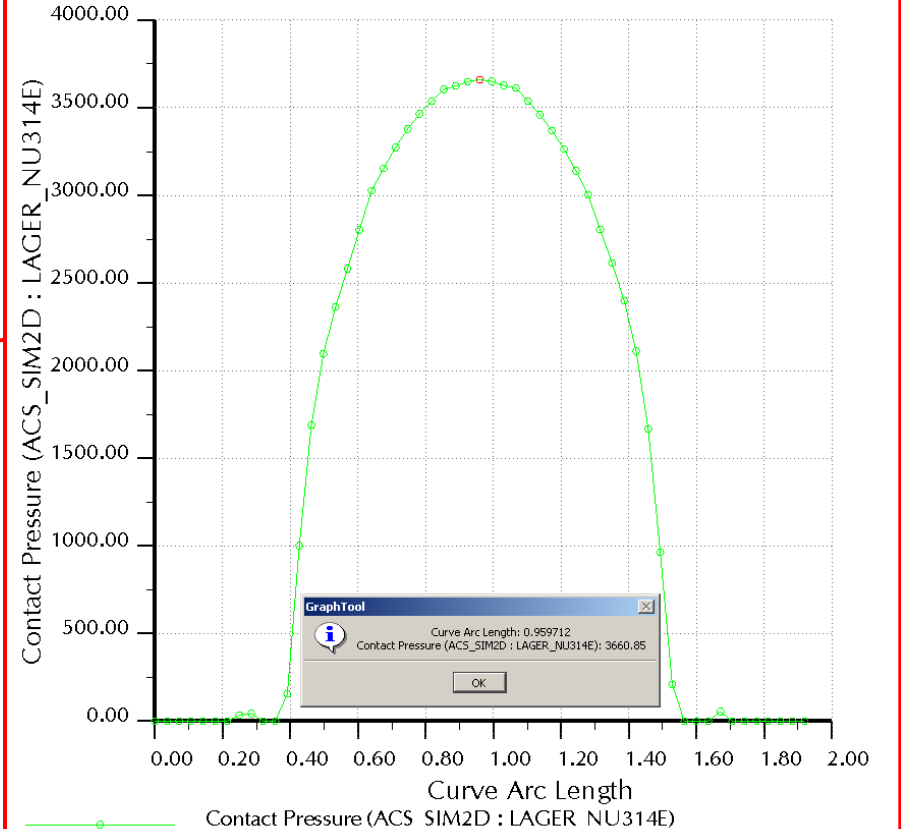



# Rolling Load in a Cylindrical Roller Bearing (18)

## Contact pressure distribution (7 rollers, large clearance, St-housing)

Contact Pressure (ACS\_SIM2D : LAGER\_NU314E)  
 (tonne / (mm sec<sup>2</sup>))  
 Curve  
 Loadset: Last\_C0\_7WK : LAGER\_NU314E

"Window1" - NU314E\_WK80\_R100\_7WK\_ST\_mp\_cp01 - NU314E\_WK80\_R100\_7WK\_ST\_mp\_cp01

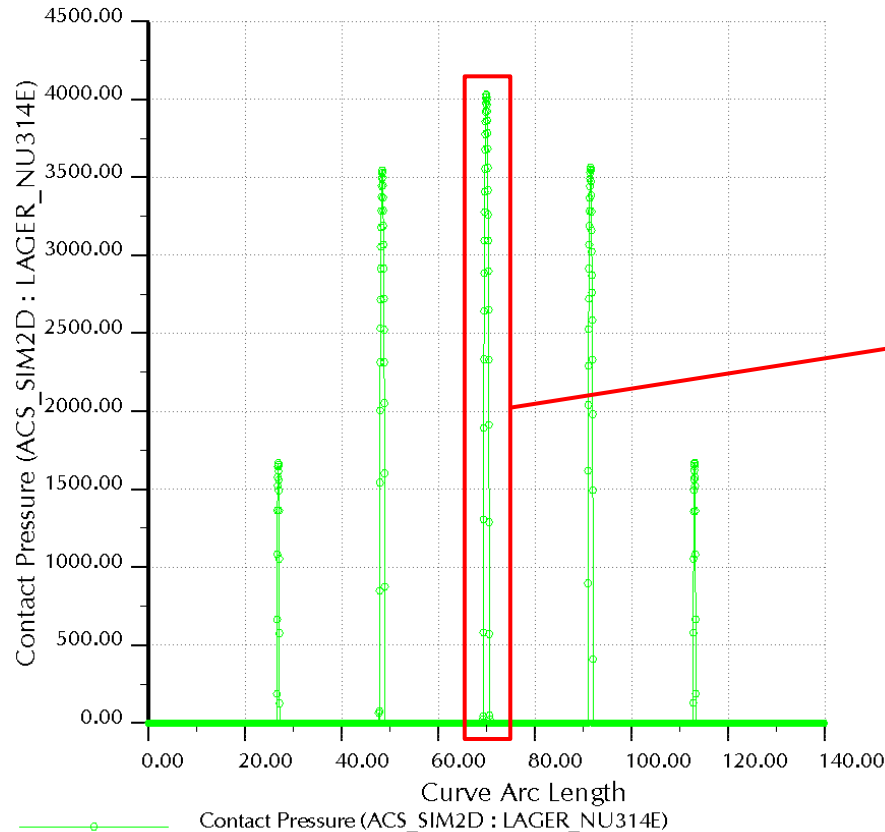

Contact Pressure (ACS\_SIM2D : LAGER\_NU314E)  
 (tonne / (mm sec<sup>2</sup>))  
 Curve  
 Loadset: Last\_C0\_7WK : LAGER\_NU314E

"Window1" - NU314E\_WK80\_R100\_7WK\_ST\_mp\_cp01 - NU314E\_WK80\_R100\_7WK\_ST\_mp\_cp01

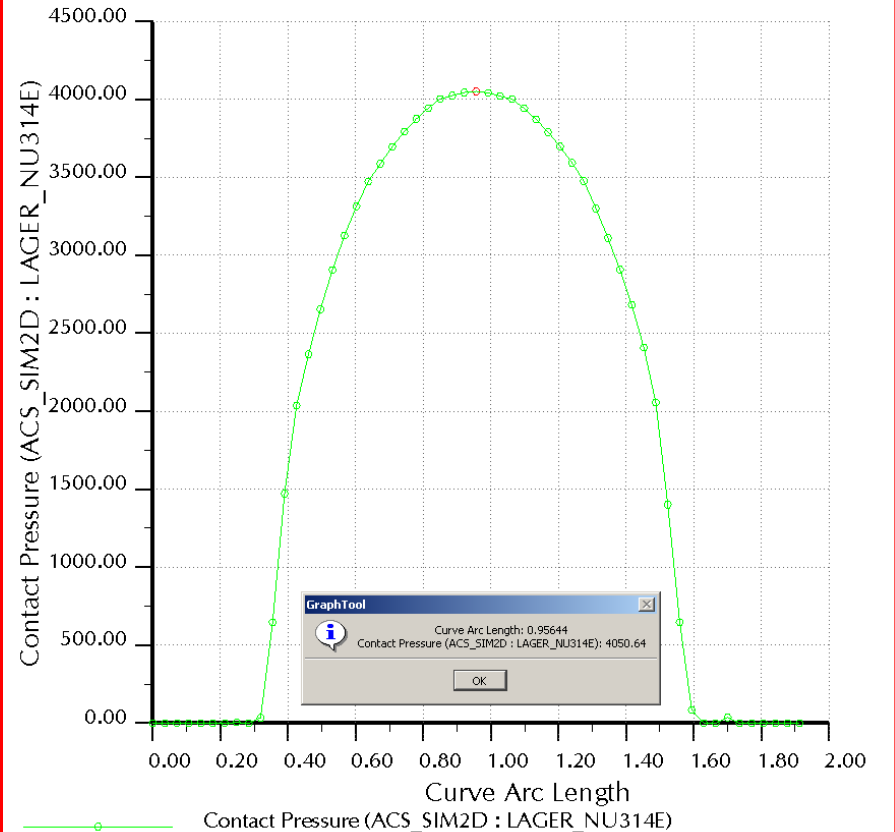

## Torque-loaded shaft-hub joint with shrink fit (1)

### Model presentation

- Interference: 100  $\mu\text{m}$
- Nominal diameter of the shrink fit: 70 mm
- Sheave outer diameter: 200 mm
- „Hub outer diameter“: 100 mm
- Hub width: 40 mm
- Torque to be transferred: 2.5 kNm (exact value 2513.27 Nm)
- Material of shaft and hub: Stainless steel,  $E=199900 \text{ MPa}$ ;  $\nu=0.27$
- Assumed coefficient of friction: 0.2 (= degreased contact surfaces, pairing St-St, after heating in a stove up to  $300^\circ \text{ C}$  acc. to Decker „Machine Elements“)

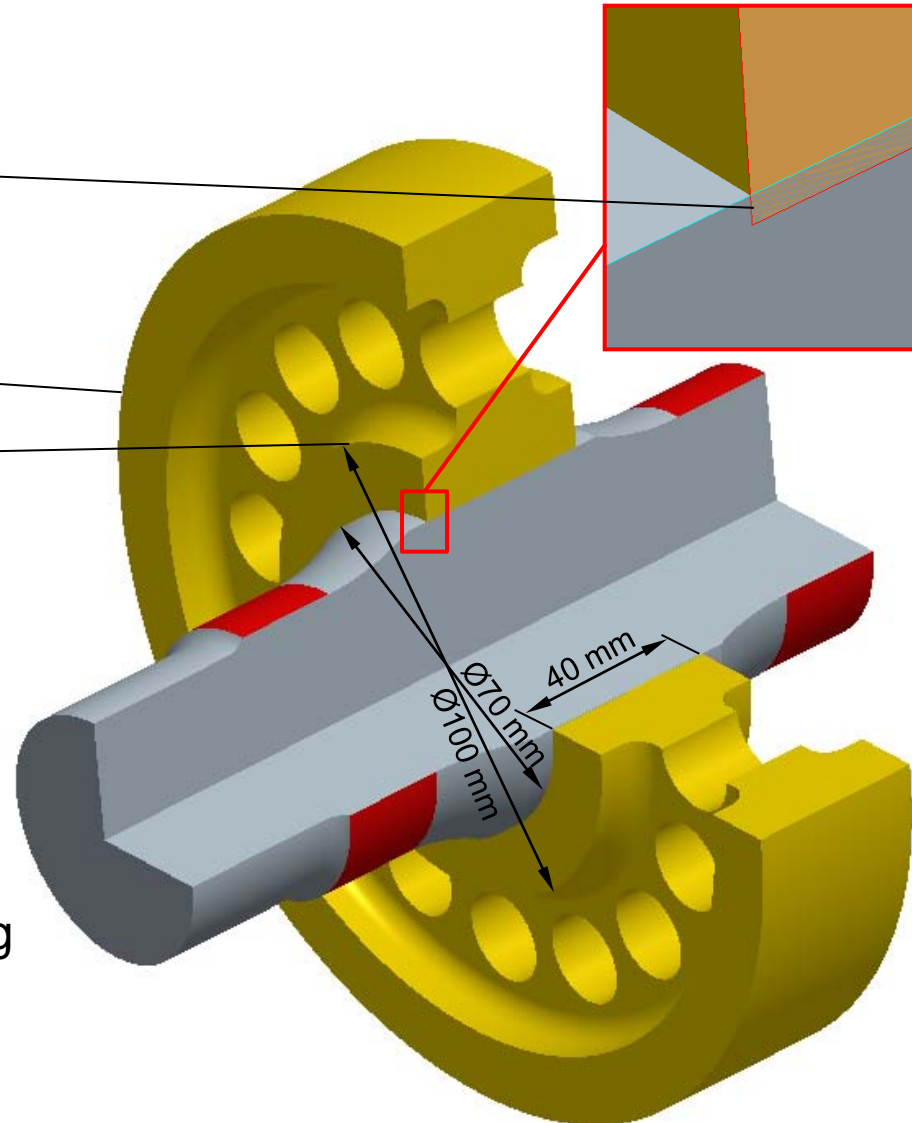

## Torque-loaded shaft-hub joint with shrink fit (2)

- Main problem of the analytical estimation of the joint pressure is, that the traction sheave is not massive, but contains holes and is skimmed. So, the analytical „substitute diameter“ is not known and must be estimated
- For massive, cylindrical hubs and shafts made of the same material, we have (when assuming a plain stress condition) for the radial stress in the joint (=negative contact pressure):

$$\sigma_r = -\frac{\Delta s}{2d} E \cdot \left( 1 - \left( \frac{d_{hub}}{D_{hub}} \right)^2 \right)$$

In this equation, we have the interference  $\Delta s = D_{shaft} - d_{hub} = 100 \mu\text{m}$  and  $d$  = the nominal joint diameter

- For our example, we obtain analytically for the radial stress:
  - With  $D_{hub} = 100 \text{ mm}$  (=diameter of the skimmed part of the hub): -73 MPa
  - With  $D_{hub} = 200 \text{ mm}$  (=outer diameter of the traction sheave): -125 MPa
- As a consequence, the real contact pressure will be between these two values and vary over the joint width

## Torque-loaded shaft-hub joint with shrink fit (3)

- To save computation time, the FE-model is set up with cyclic symmetry (3D-contact needs significantly more computation time than 2D-contact!)

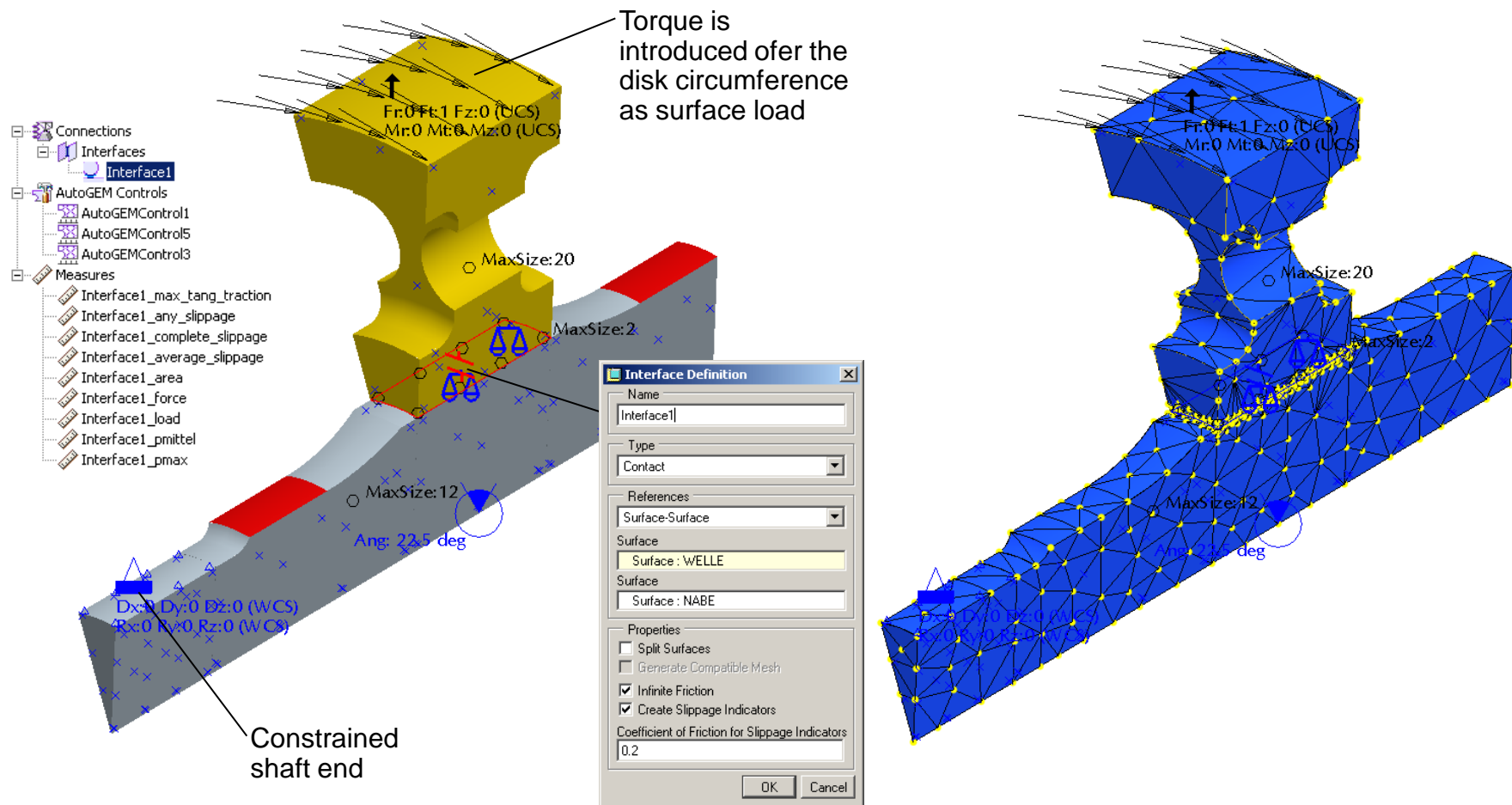

# Torque-loaded shaft-hub joint with shrink fit (4)

- Results of the pure shrink fit case (without operational load)

Displacement R (ACSO ; WNV)  
 (mm)  
 Deformed  
 Max Disp +4.2800E-02  
 Scale 2.5000E+02

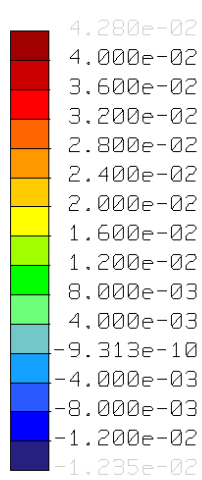

Stress von Mises (WCS)  
 (tonne / (mm sec^2))  
 Deformed  
 Scale 2.5000E+02

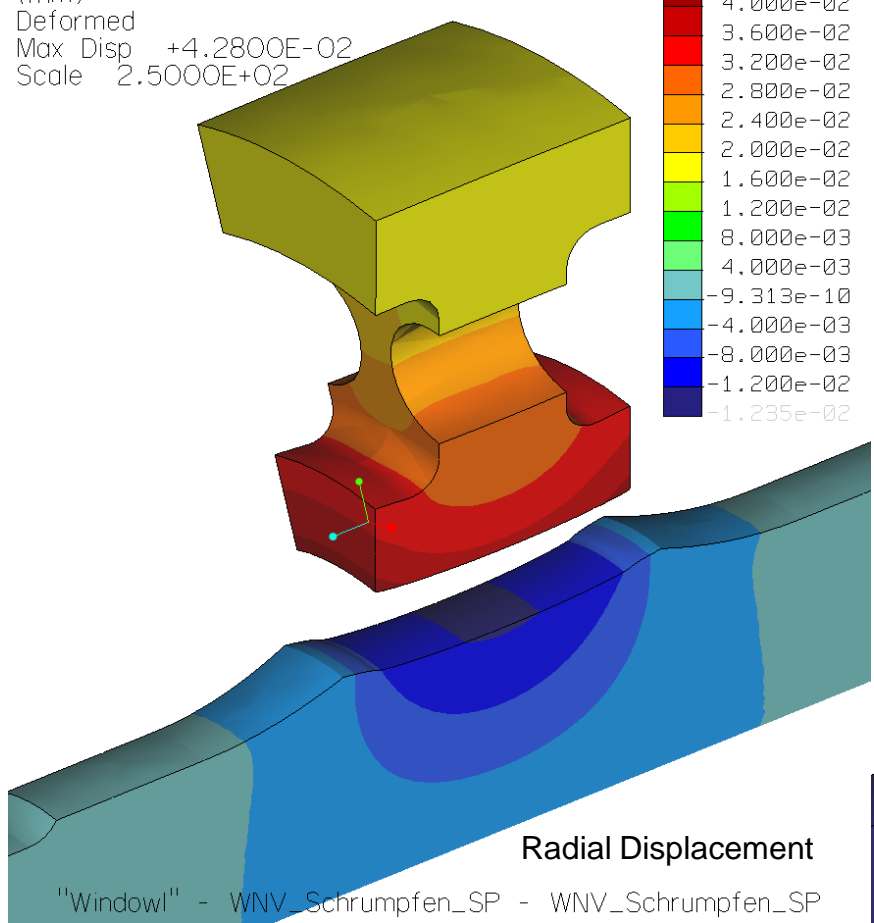
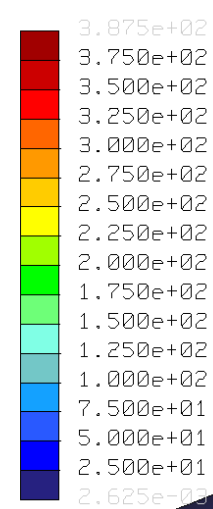

Radial Displacement

"Window1" - WNV\_Schrumpfen\_SP - WNV\_Schrumpfen\_SP

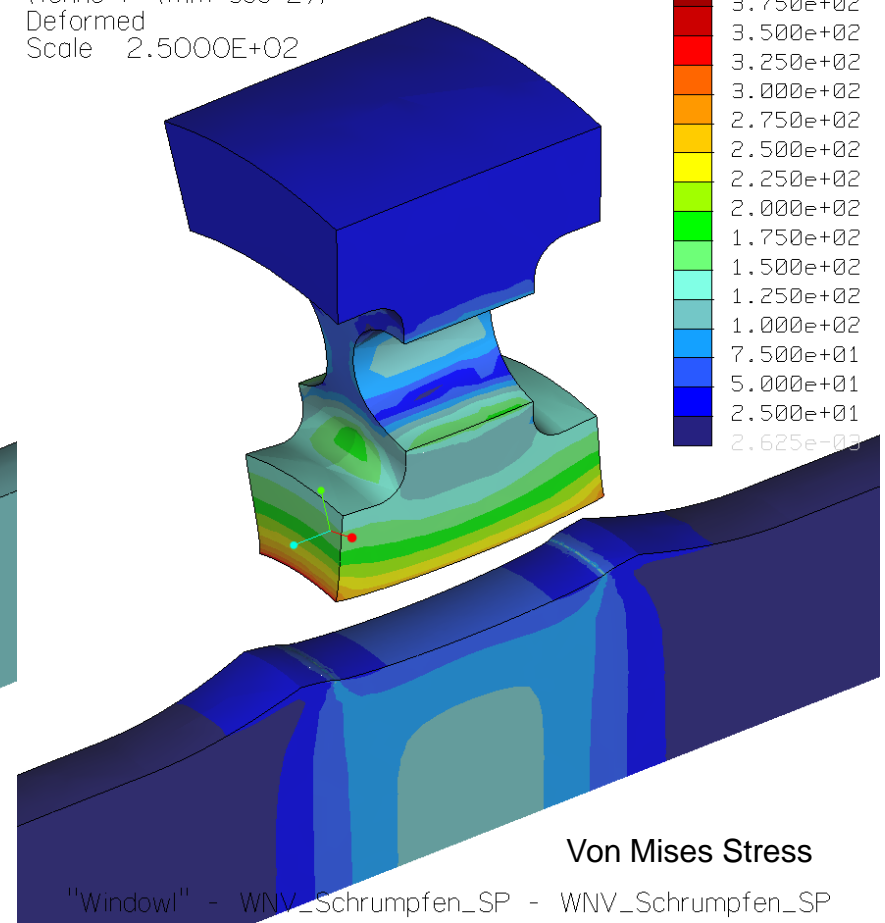

Von Mises Stress

"Window1" - WNV\_Schrumpfen\_SP - WNV\_Schrumpfen\_SP

# Torque-loaded shaft-hub joint with shrink fit (5)

- Results of the pure shrink fit case (without operational load)

Stress RR (ACSO ; WNV)  
 (tonne / (mm sec<sup>2</sup>))  
 Deformed  
 Scale 2.5000E+02

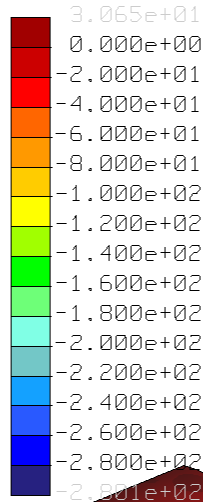

Stress TT (ACSO ; WNV)  
 (tonne / (mm sec<sup>2</sup>))  
 Deformed  
 Scale 2.5000E+02

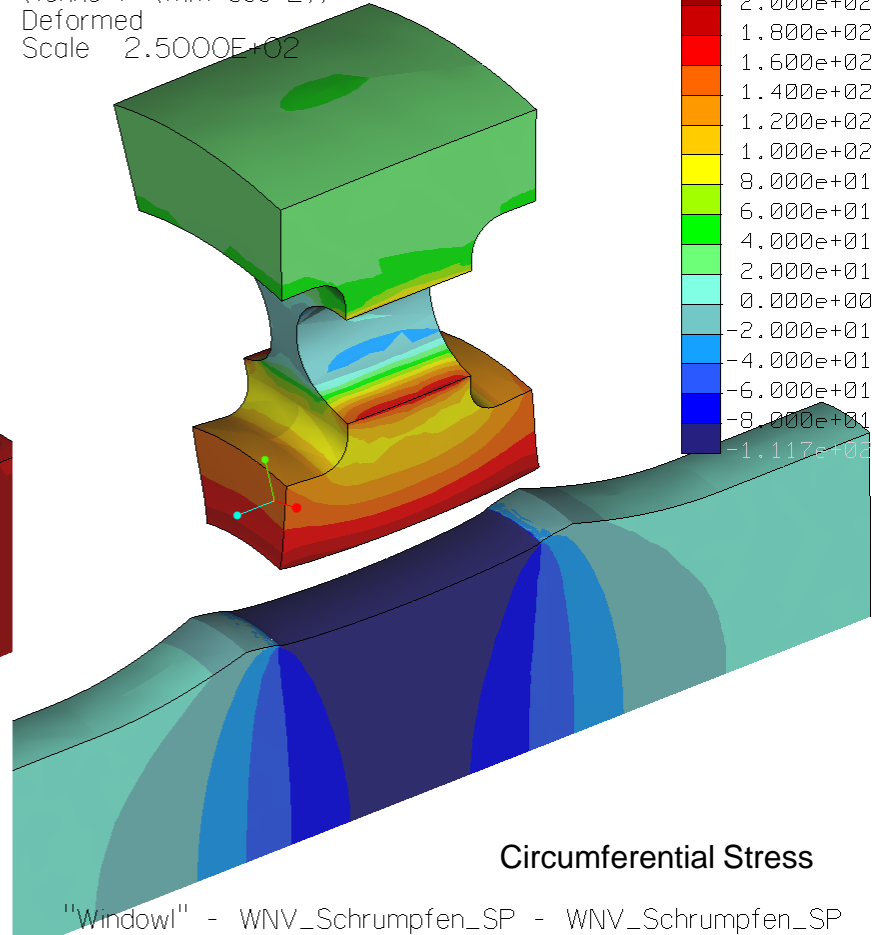
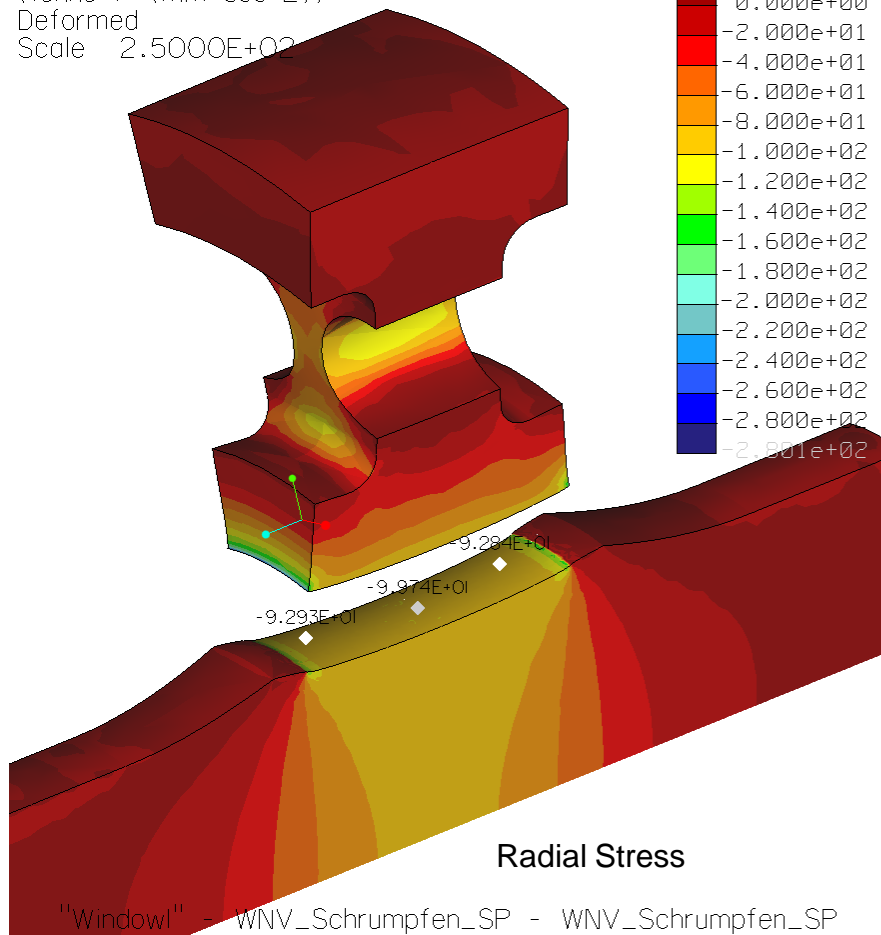
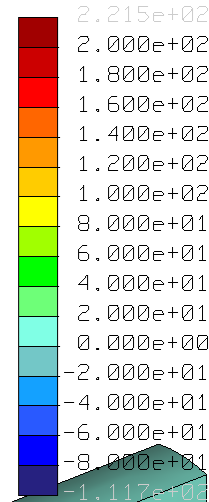

# Torque-loaded shaft-hub joint with shrink fit (6)

- Results of the pure shrink fit case (without operational load)

```

Run Status (WNV_Schrumpfen_SP.rpt) Not Running

Resultant Load on Model:
  in global X direction: -2.281467e-10
  in global Y direction: -8.769315e-11
  in global Z direction: 2.773179e-10

Measures:

contact_area: 5.484699e+02
contact_max_pres: 2.801220e+02
max_beam_bending: 0.000000e+00
max_beam_tensile: 0.000000e+00
max_beam_torsion: 0.000000e+00
max_beam_total: 0.000000e+00
max_disp_mag: 4.328859e-02
max_disp_x: 1.637817e-02
max_disp_y: 4.280035e-02
max_disp_z: -1.294859e-02
max_prin_mag: -2.805271e+02
max_rot_mag: 0.000000e+00
max_rot_x: 0.000000e+00
max_rot_y: 0.000000e+00
max_rot_z: 0.000000e+00
max_stress_prin: 2.216462e+02
max_stress_vm: 3.875086e+02
max_stress_xx: 2.204007e+02
max_stress_xy: -1.569297e+02
max_stress_xz: -2.380826e+01
max_stress_yy: -2.764909e+02
max_stress_yz: -6.971583e+01
max_stress_zz: -1.157625e+02
min_stress_prin: -2.805271e+02
strain_energy: 1.361510e+03
Interface1_any_slippage: 4.515686e+01
Interface1_area: 5.484699e+02
Interface1_average_slippage: -1.754207e+01
Interface1_complete_slippage: -4.654791e+01
Interface1_force: 5.419508e+04
Interface1_load: 5.443004e+04
Interface1_max_tang_traction: 7.105713e+01
Interface1_pmax: 2.801220e+02
Interface1_pmittel: 9.923978e+01

** Warning: Contact slippage measure "Interface1_any_slippage"
is positive. The assumption of infinite friction for this contact
interface may not be valid.
  
```

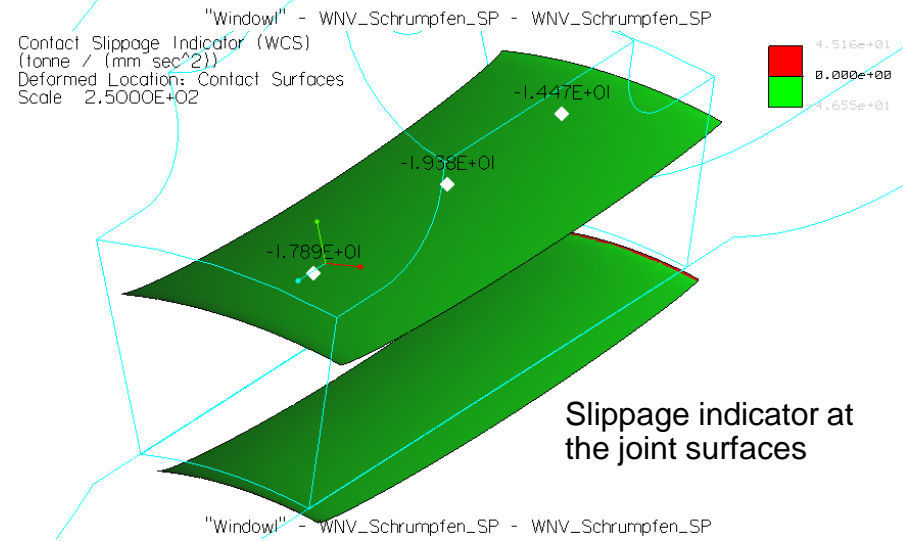
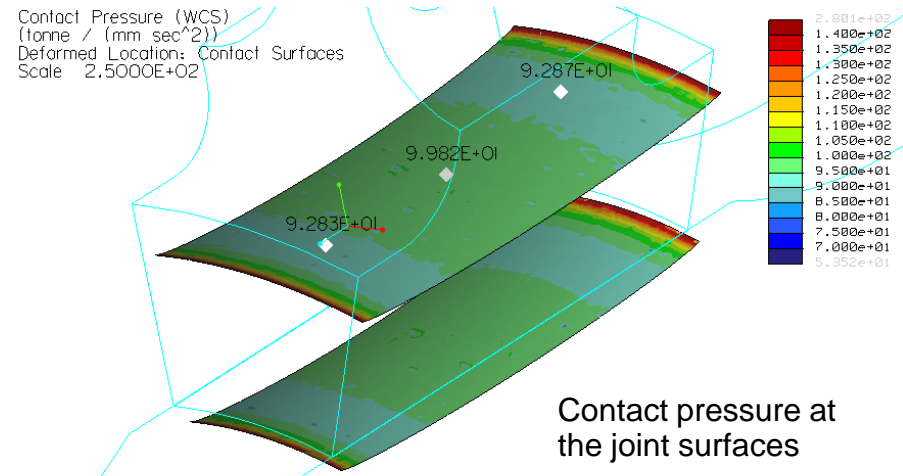

# Torque-loaded shaft-hub joint with shrink fit (7)

- Results with shrink fit and additional torque load

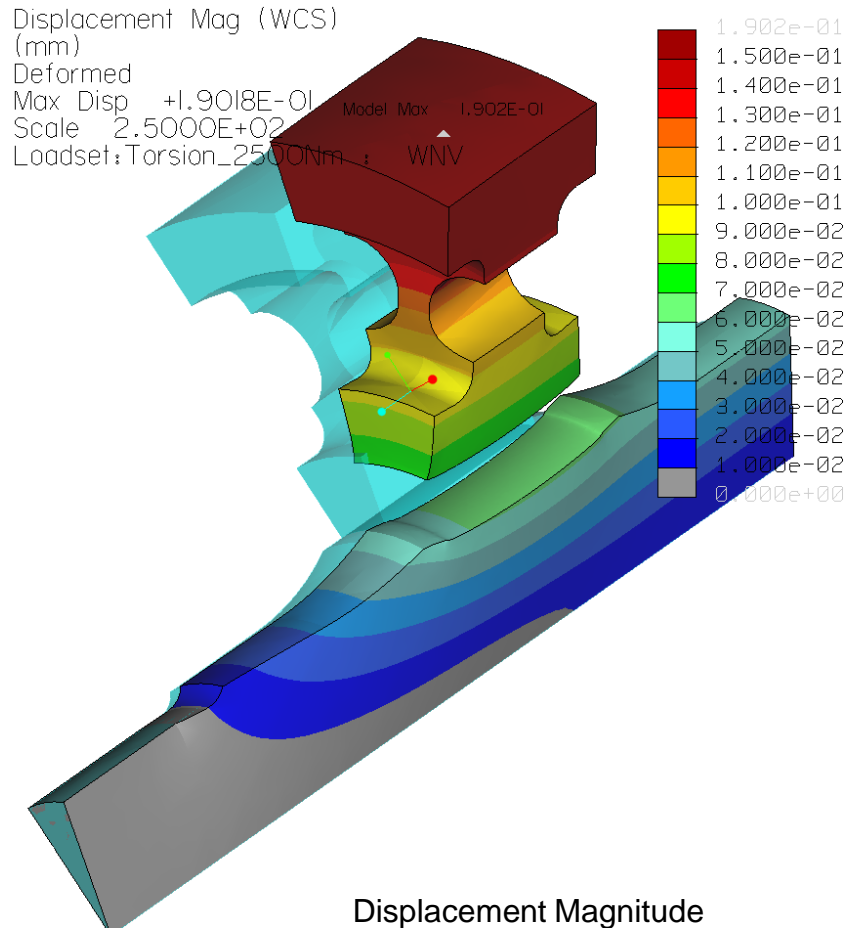

"Window1" - WNV\_Torsion\_SP - WNV\_Torsion\_SP

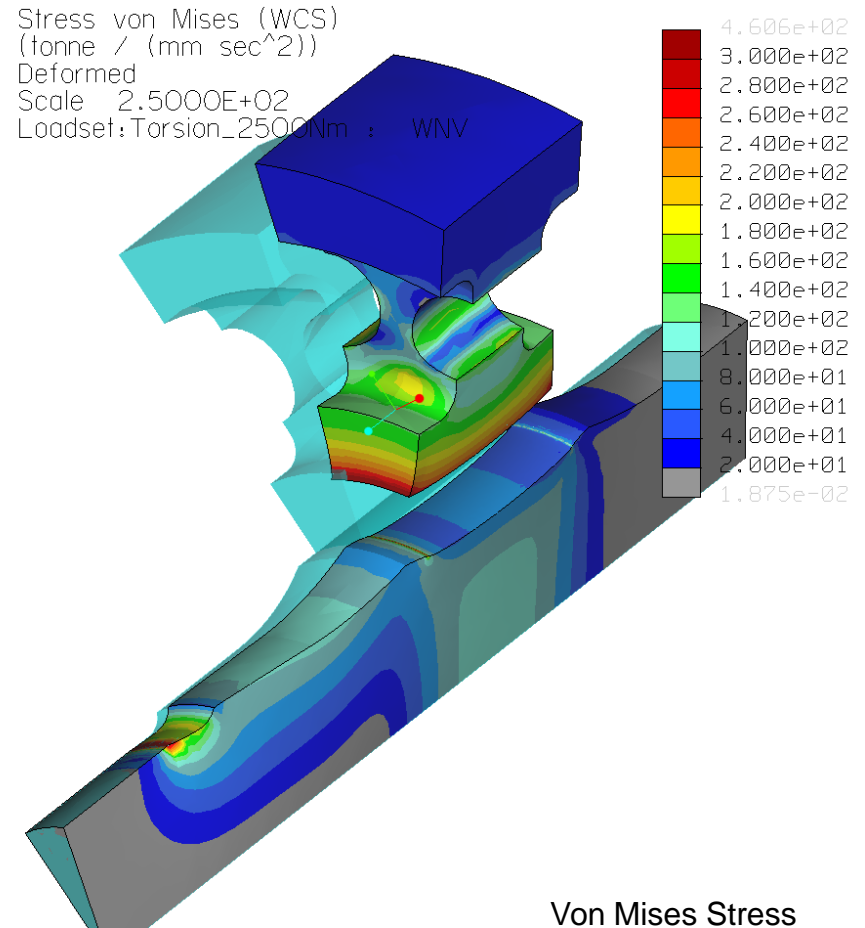

"Window1" - WNV\_Torsion\_SP - WNV\_Torsion\_SP



# Torque-loaded shaft-hub joint with shrink fit (8)

- Results with shrink fit and additional torque load

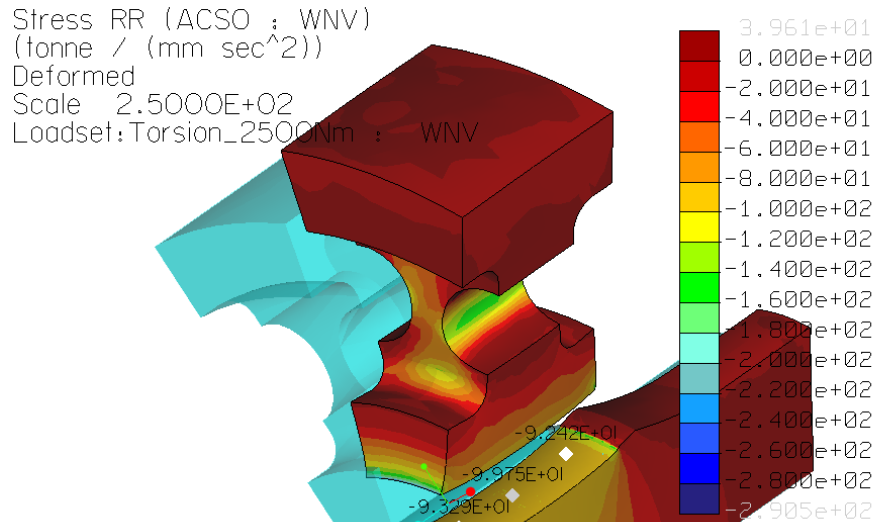

Radial Stress

"Window1" - WNV\_Torsion\_SP - WNV\_Torsion\_SP

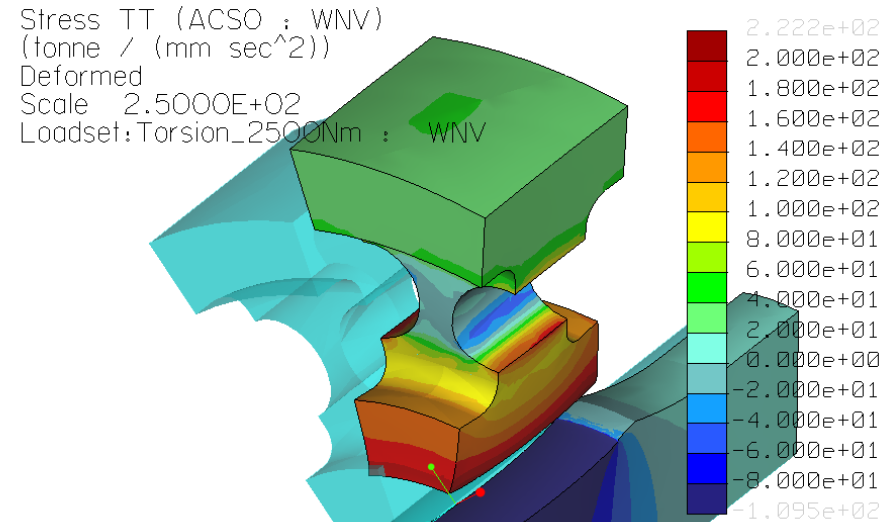

Tangential Stress

"Window1" - WNV\_Torsion\_SP - WNV\_Torsion\_SP

# Torque-loaded shaft-hub joint with shrink fit (9)

- Results with shrink fit and additional torque load

Stress Max Prin (WCS)  
 (tonne / (mm sec<sup>2</sup>))  
 Deformed  
 Scale 2.5000E+02  
 Loadset: Torsion\_2500Nm : WNV

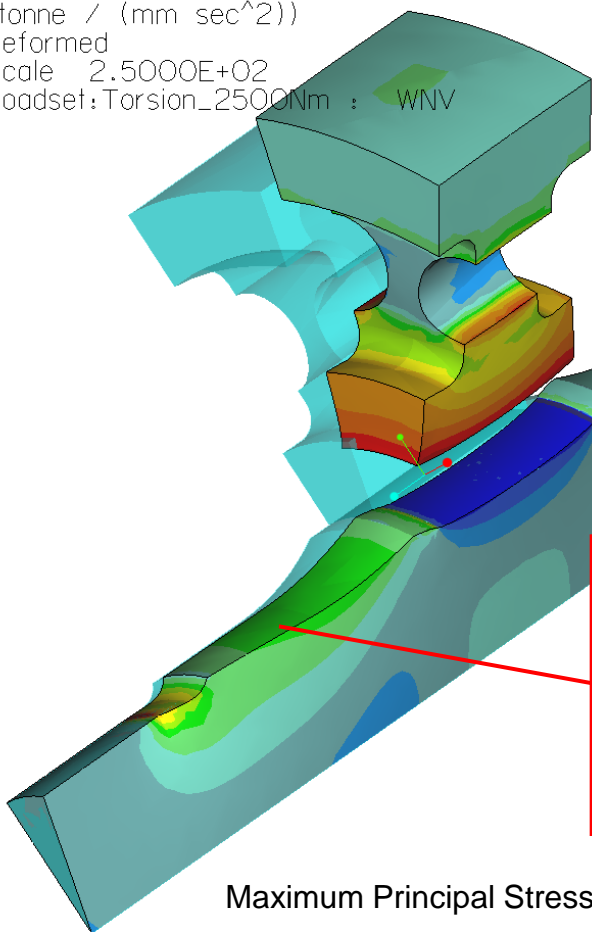
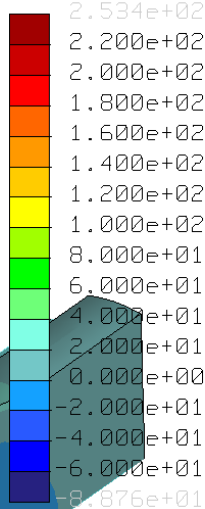

Maximum Principal Stress  $\sigma_1$

"Window1" - WNV\_Torsion\_SP - WNV\_Torsion\_SP

Stress Min Prin (WCS)  
 (tonne / (mm sec<sup>2</sup>))  
 Deformed  
 Scale 2.5000E+02  
 Loadset: Torsion\_2500Nm : WNV

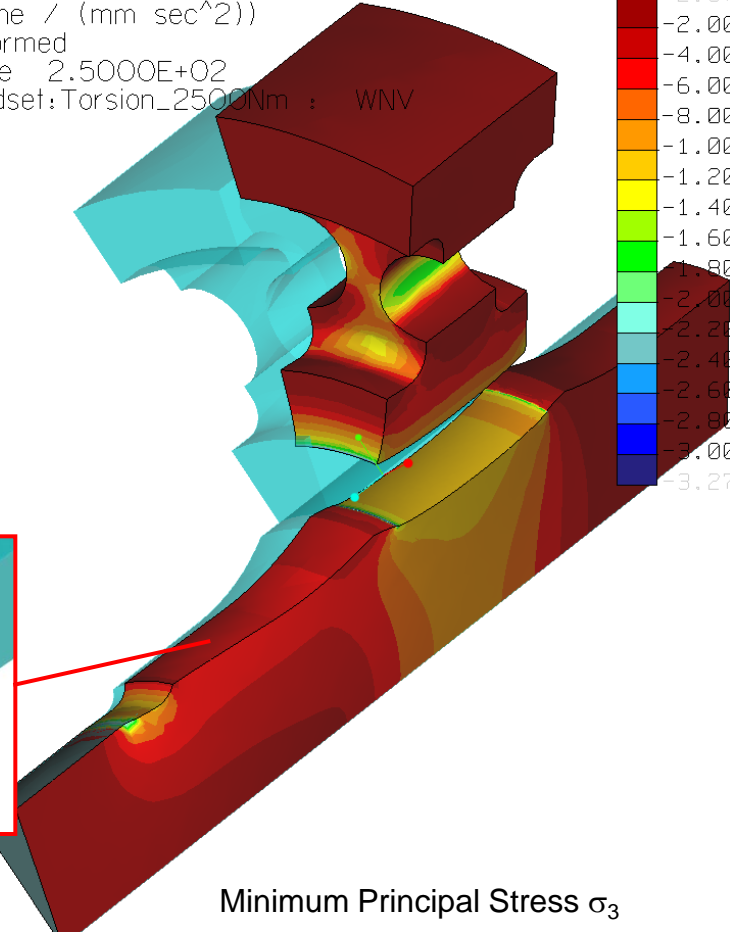
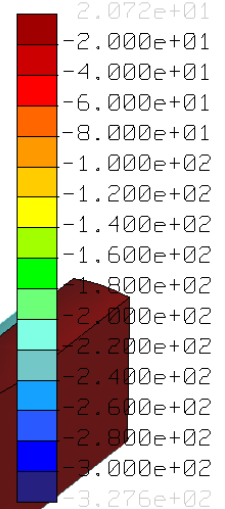

Minimum Principal Stress  $\sigma_3$

"Window1" - WNV\_Torsion\_SP - WNV\_Torsion\_SP

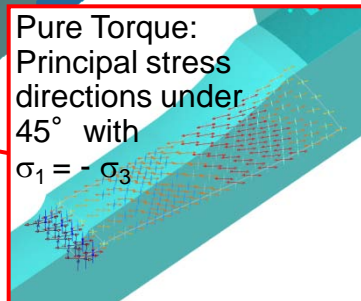

# Torque-loaded shaft-hub joint with shrink fit (10)

- Results with shrink fit and additional torque load

Run Status (WNV\_Torsion\_SP.rpt) Not Running

```

Resultant Load on Model:
  in global X direction: 1.530734e+03
  in global Y direction: -3.044819e+02
  in global Z direction: 3.921983e-10

Measures:

contact_area: 5.484676e+02
contact_max_pres: 2.904950e+02
max_beam_bending: 0.000000e+00
max_beam_tensile: 0.000000e+00
max_beam_torsion: 0.000000e+00
max_beam_total: 0.000000e+00
max_disp_mag: 1.901820e-01
max_disp_x: 1.898841e-01
max_disp_y: -5.725347e-02
max_disp_z: -1.294733e-02
max_prin_mag: -3.276122e+02
max_rot_mag: 0.000000e+00
max_rot_x: 0.000000e+00
max_rot_y: 0.000000e+00
max_rot_z: 0.000000e+00
max_stress_prin: 2.533832e+02
max_stress_vm: 4.606242e+02
max_stress_xx: 2.221020e+02
max_stress_xy: -1.931418e+02
max_stress_xz: -1.602552e+02
max_stress_yy: -3.056323e+02
max_stress_yz: 1.121951e+02
max_stress_zz: -1.131769e+02
min_stress_prin: -3.276122e+02
strain_energy: 1.509055e+03
Interface1_any_slippage: 9.891086e+01
Interface1_area: 5.484676e+02
Interface1_average_slippage: -1.084770e+01
Interface1_complete_slippage: -4.410185e+01
Interface1_force: 5.437415e+04
Interface1_load: 5.442755e+04
Interface1_max_tang_traction: 1.511150e+02
Interface1_pmax: 2.904950e+02
Interface1_pmittel: 9.923567e+01

** Warning: Contact slippage measure "Interface1_any_slippage"
is positive. The assumption of infinite friction for this contact
interface may not be valid.

```

Detailed Summary

Close

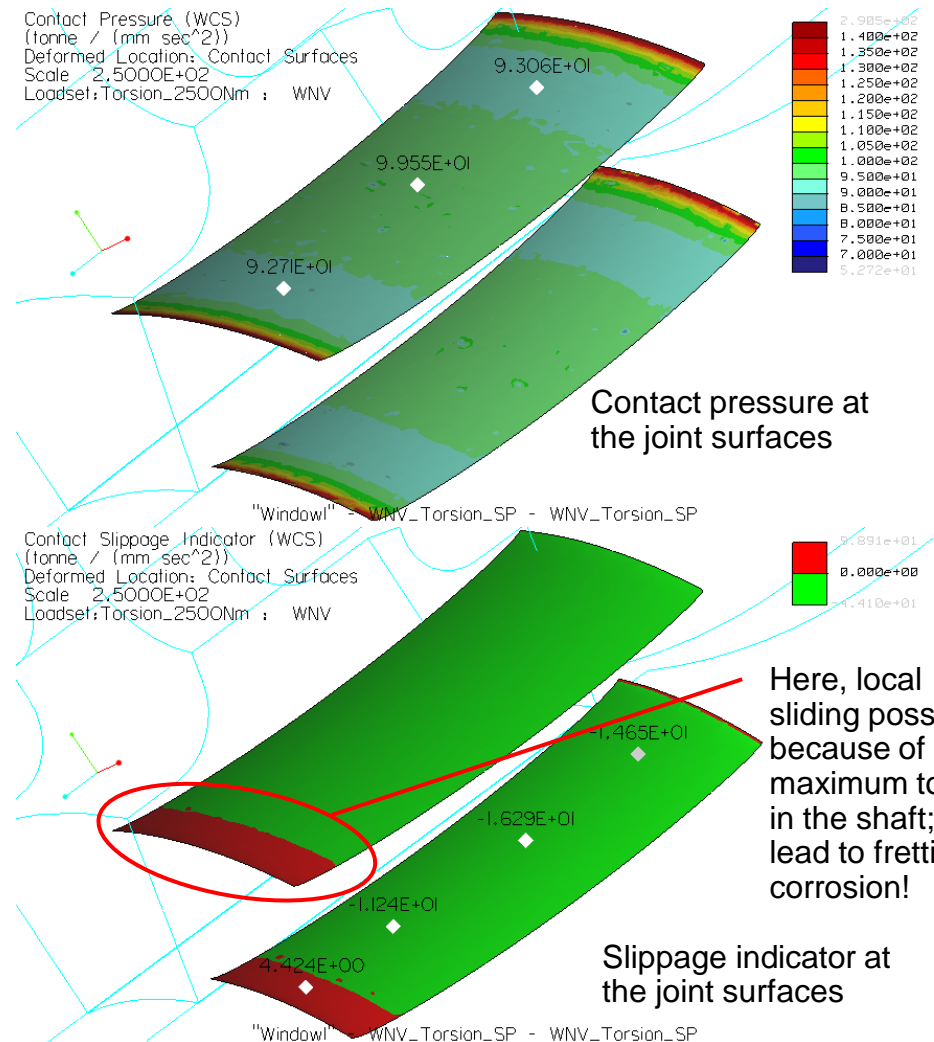

# Torque-loaded shaft-hub joint with shrink fit (11)

- Results with shrink fit and additional torque load

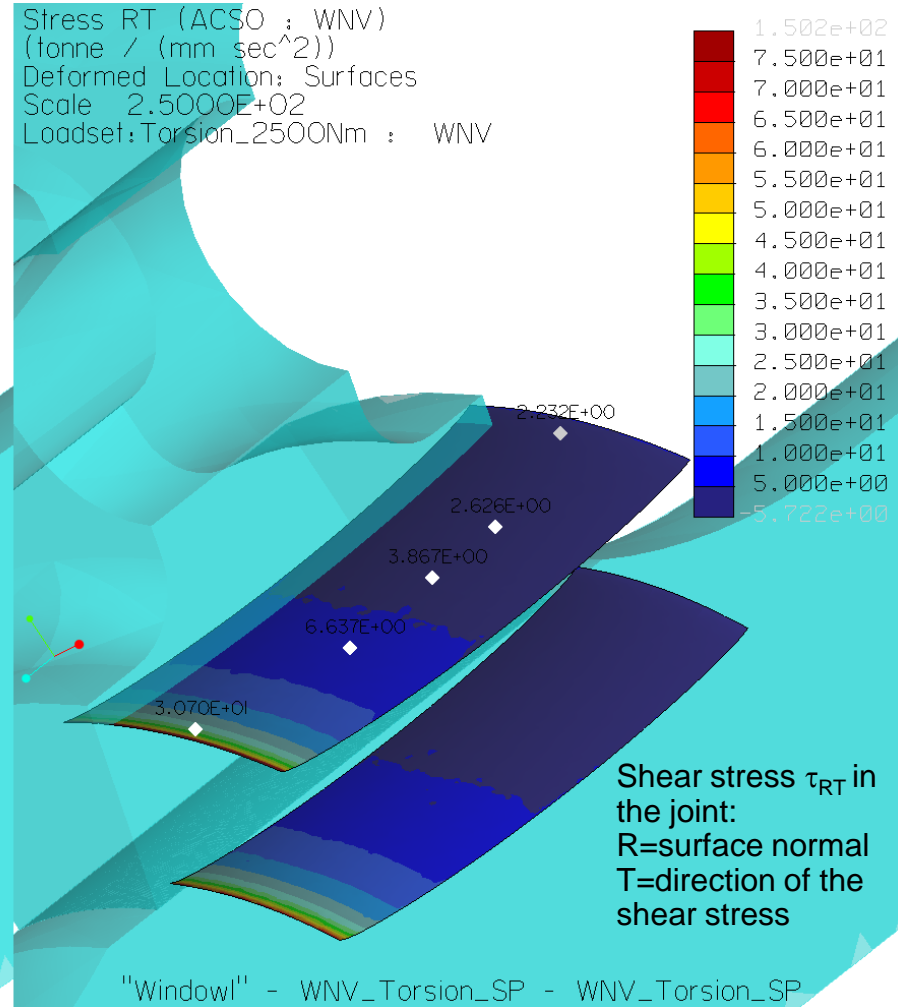
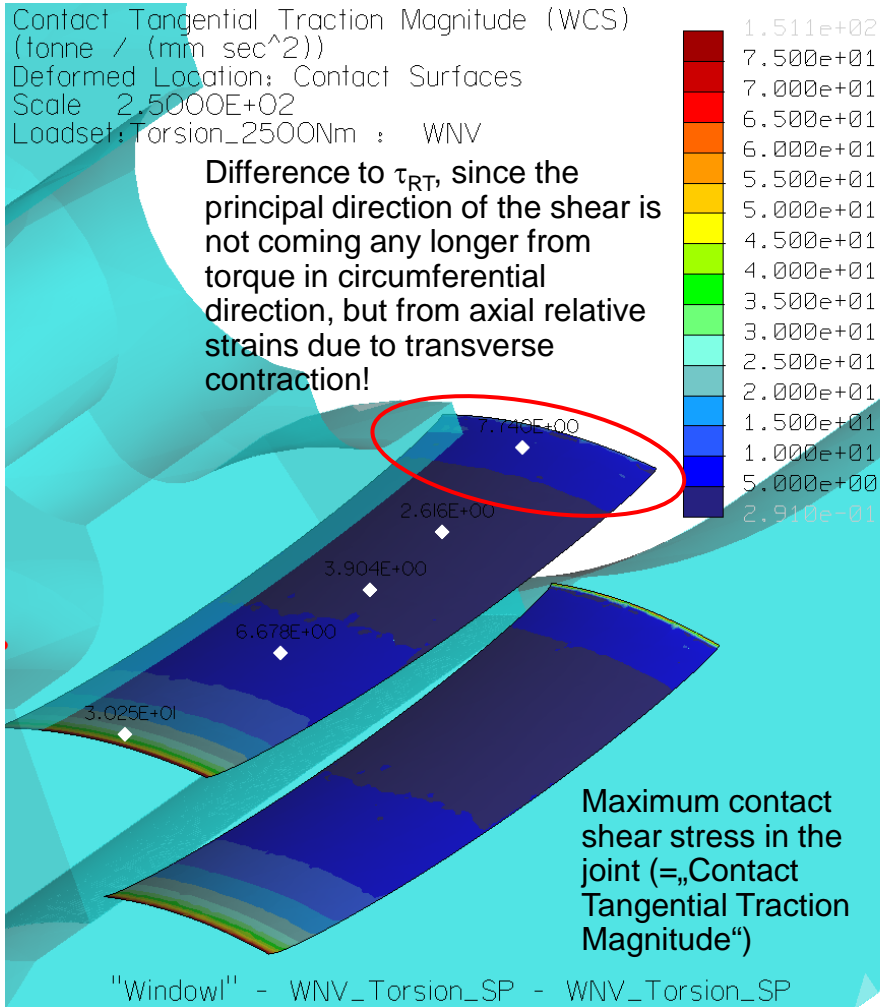

## Torque-loaded shaft-hub joint with shrink fit (12)

### Additional consideration: Influence of the stress state and friction

(see post processor plots of the two following slides)

- The shown analytical solution for the radial stress at the joint (see slide 43) assumes a plane stress conditions which means, axial stresses are being neglected. This is confirmed by a Mechanics analysis with a 2D plane stress model, which results in a radial stress at the hub inner surface of -73MPa (for a hub outer diameter of 100 mm). Furthermore, an 2D axial symmetric model with friction-free contact leads to the same value (see upper images of the next slide)
- If we assume complete sticking at the contact surfaces (=infinite friction) and a very long shrink fit, we could analyze the connection with a 2D plain strain model. This increases the joint pressure from 73 to 100 MPa (lower left image next slide)
- If we assume complete sticking (infinite friction) in a model of finite length (hub width 40 mm), we have a 2D plane strain condition just approximately in the middle of the connection: This leads to a max. radial stress of approx. -98 MPa in the axial symmetric model with infinite friction, shown in the lower right image next slide. But, here the assumption of infinite friction is not valid over long areas of the connection (see positive slippage indicator results on slide 55), so the assumption of a plane stress model for the classical analytical equation of slide 43 does make sense!

# Torque-loaded shaft-hub joint with shrink fit (13)

All plots show the radial stress in the connection with 100  $\mu\text{m}$  interference fit and 100 mm hub outer diameter, see slide 42+43!

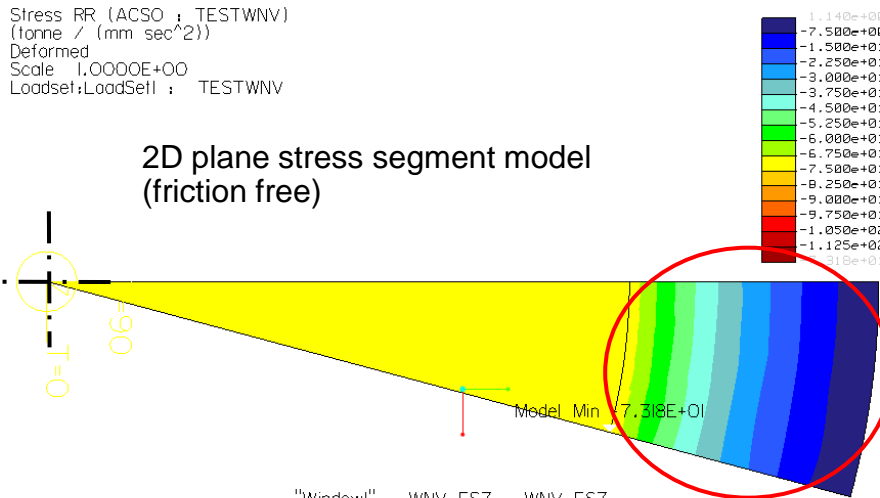

"Window1" - WNV\_ESZ - WNV\_ESZ

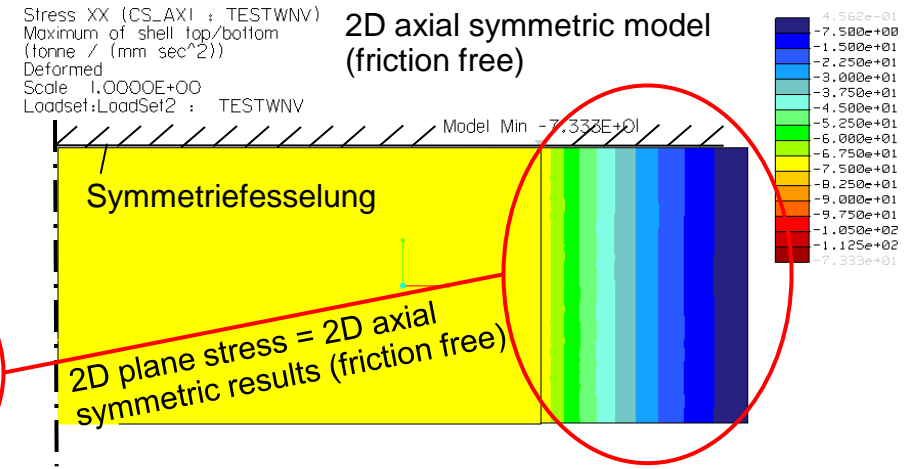

"Window3" - Welle\_AX1\_ohneReibung\_iso\_hs - Welle\_AX1\_ohneReibung\_iso\_hs

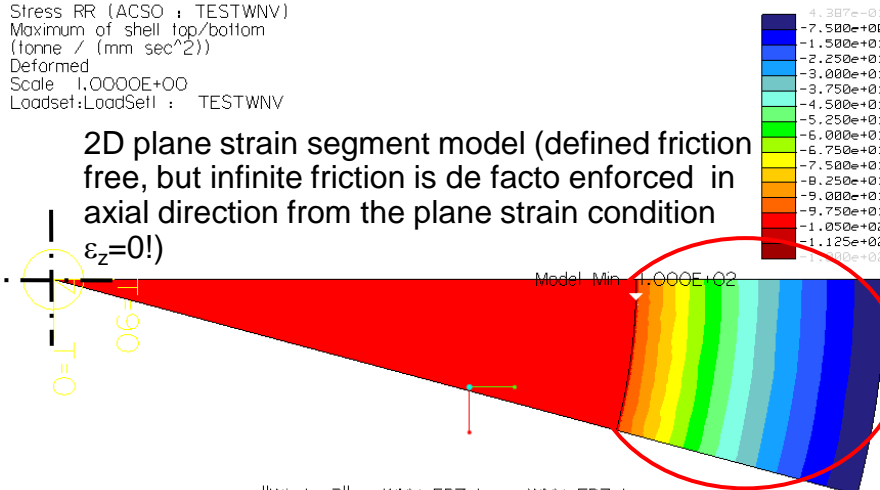

"Window2" - WNV\_EDZ\_hs - WNV\_EDZ\_hs

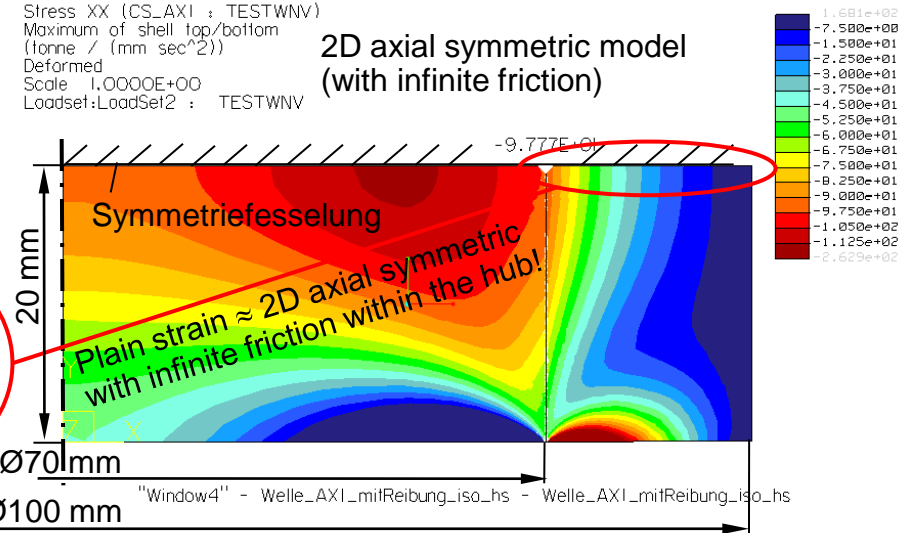

"Window4" - Welle\_AX1\_mitReibung\_iso\_hs - Welle\_AX1\_mitReibung\_iso\_hs

# Torque-loaded shaft-hub joint with shrink fit (14)

Stress XX (CS\_AXI : TESTWNV)  
 Maximum of shell top/bottom  
 (tonne / (mm sec<sup>2</sup>))  
 Deformed  
 Scale 1.0000E+00  
 Loadset:LoadSet2 : TESTWNV

2D axial symmetric model  
 (with infinite friction)

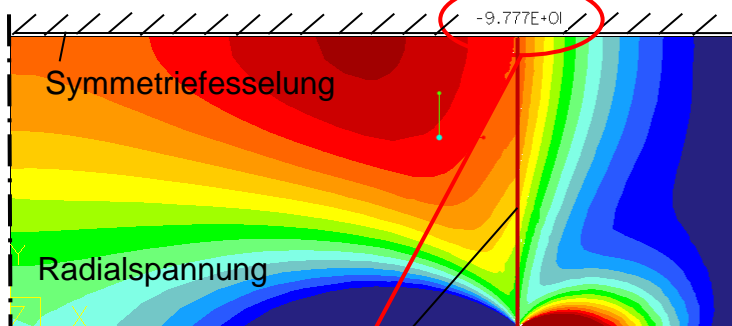
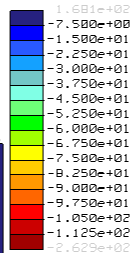

Ausgewerteter Pfad (Nabeninnenseite)

Contact Pressure (CS\_AXI : TESTWNV)  
 (tonne / (mm sec<sup>2</sup>))  
 Curve  
 Loadset:LoadSet2 : TESTWNV

"Window1" - Welle\_AXI\_mitReibung\_iso\_hs - Welle\_AXI\_mitReibung\_iso\_hs

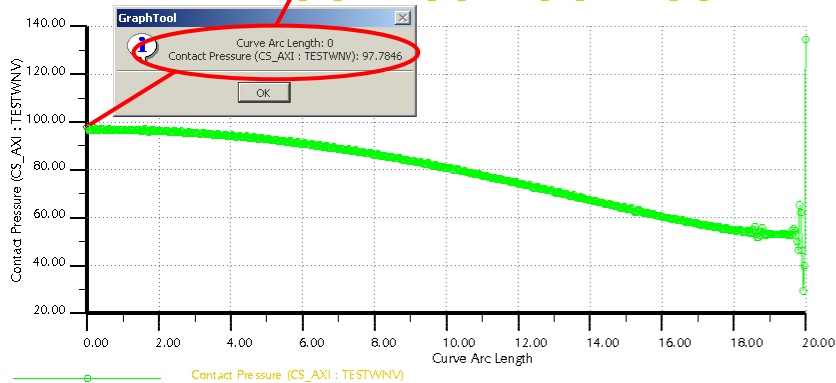

Contact Slippage Indicator (CS\_AXI : TESTWNV)  
 (tonne / (mm sec<sup>2</sup>))  
 Curve  
 Loadset:LoadSet2 : TESTWNV

"Window1" - Welle\_AXI\_mitReibung\_iso\_hs - Welle\_AXI\_mitReibung\_iso\_hs

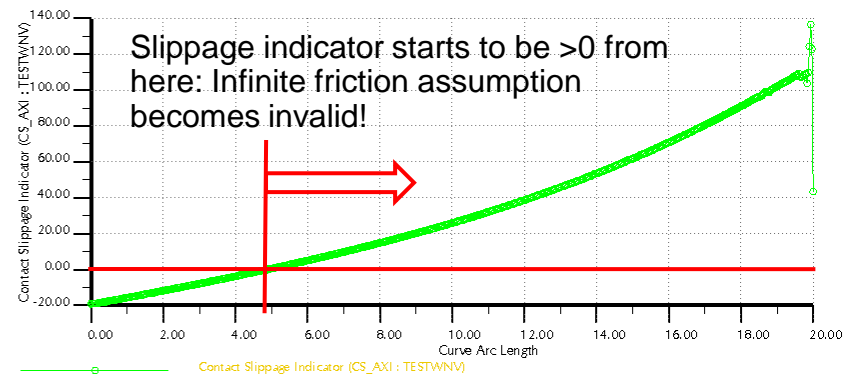

Contact Tangential Traction Magnitude (CS\_AXI : TESTWNV)  
 (tonne / (mm sec<sup>2</sup>))  
 Curve  
 Loadset:LoadSet2 : TESTWNV

"Window1" - Welle\_AXI\_mitReibung\_iso\_hs - Welle\_AXI\_mitReibung\_iso\_hs

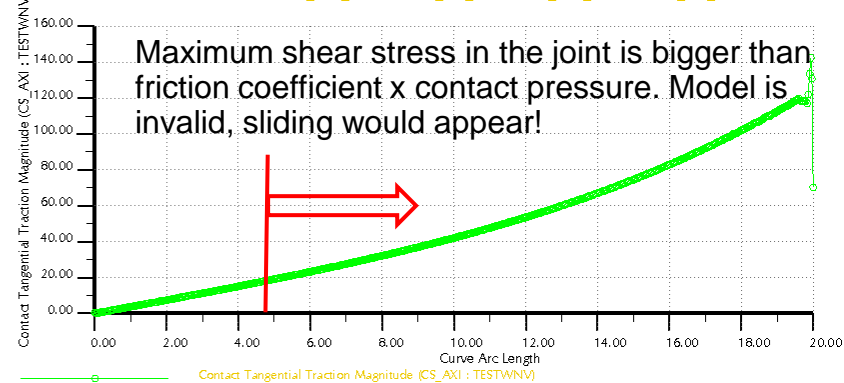

## Torque-loaded shaft-hub joint with shrink fit (15)

### 2. consideration: Influence of the „mounting procedure“

- If we compare the slippage indicator results from the 2D axial symmetric analysis of the shaft-hub-connection with infinite friction with the previously treated 3D-segment model, we observe that for the latter the indicator is nearly everywhere  $<0$  (=valid model), whereas in the 2D-model we obtain mostly values  $>0$  (=invalid model).
- Furthermore, due to the similar interference we would expect higher stresses in the 3D-model because of its bigger outer diameter (200 mm instead of 100 mm) - despite the holes. In fact, the contact pressure in the middle of the connection is approx. similar in both models with nearly 100 MPa.
- The reason is the following: In opposite to the 3D segment model of the real connection, in all 2D models the 100  $\mu\text{m}$  interference fit was not obtained by initial interference in the Pro/E-Geometry, but by cooling down the hub acc. to  $\Delta l = l_1 \alpha \Delta T$ ! So, we have simulated the mounting procedure from thermal shrinking of the hub, which of course also creates shrinking in axial direction and so leads to additional shear stresses. In opposite to this, in the 3D initial interference model, shear stresses are created only by the much smaller axial transverse contraction effect!



## Torque-loaded shaft-hub joint with shrink fit (16)

- In reality, these shear stresses disappear as soon as the sticking friction in the joint is not big enough any more. So, the result of the 3D segment model with initial interpenetration is for sure more realistic than that of the 2D axial symmetric model with „thermal mounting“ (because of the predominantly positive slippage indicator in the 2D model).
- If we want to obtain in the 2D axial symmetric model a result like in the 3D initial interference model, we have to use orthotropic material for the hub, in which we set the axial CTE equal to Zero. This can be compared better with a mounting procedure with pressurized oil, where axial length changes are created just by the transverse contraction and not from additional thermal strains!
- **Important in all analyses with thermal shrinking with axial length change and infinite friction (in case of 2D plane strain also without friction) is, that the model must have at the beginning exactly a zero-gap and no additional gap, which has to be closed first „stress free“ from cooling the model down: In this case we would obtain an error in the result, since the condition of equilibrium is always done at the undeformed geometry!**
- The following slide shows the behavior of the 2D axial symmetric model with friction and orthotropic material (so without axial thermal strain!), which can now be compared better with the 3D initial interference model. The remaining difference is just from the different outer diameters of the hubs!

# Torque-loaded shaft-hub joint with shrink fit (17)

Stress XX (CS\_AXI : TESTWNV)  
 Maximum of shell top/bottom  
 (tonne / (mm sec<sup>2</sup>))  
 Deformed  
 Scale 1.0000E+00  
 Loadset:LoadSet2 : TESTWNV

Axial symmetric model without  
axial thermal strains (with  
 infinite friction)

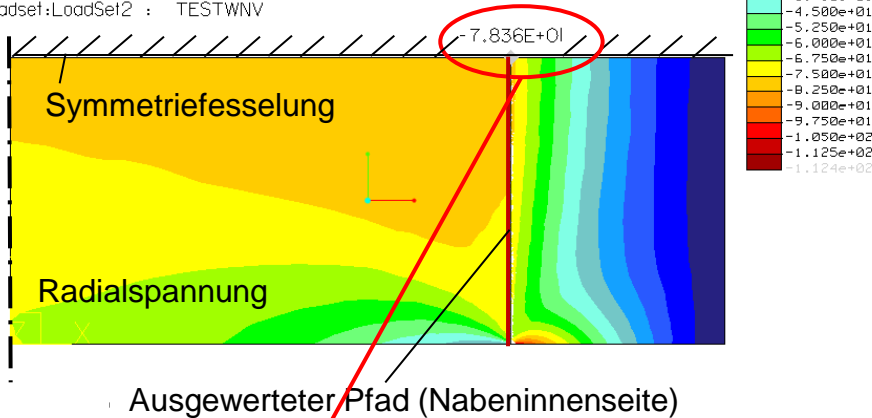

Contact Pressure (CS\_AXI : TESTWNV)  
 (tonne / (mm sec<sup>2</sup>))  
 Curve  
 Scale 1.0000E+00  
 Loadset:LoadSet2 : TESTWNV

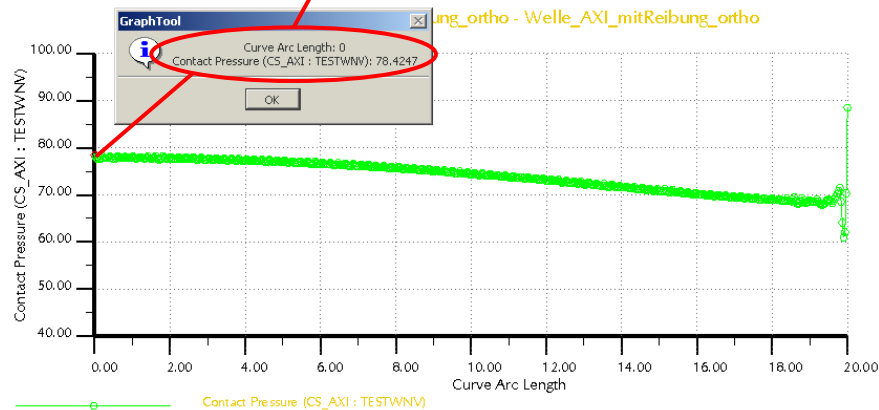

Contact Slippage Indicator (CS\_AXI : TESTWNV)  
 (tonne / (mm sec<sup>2</sup>))  
 Curve  
 Scale 1.0000E+00  
 Loadset:LoadSet2 : TESTWNV

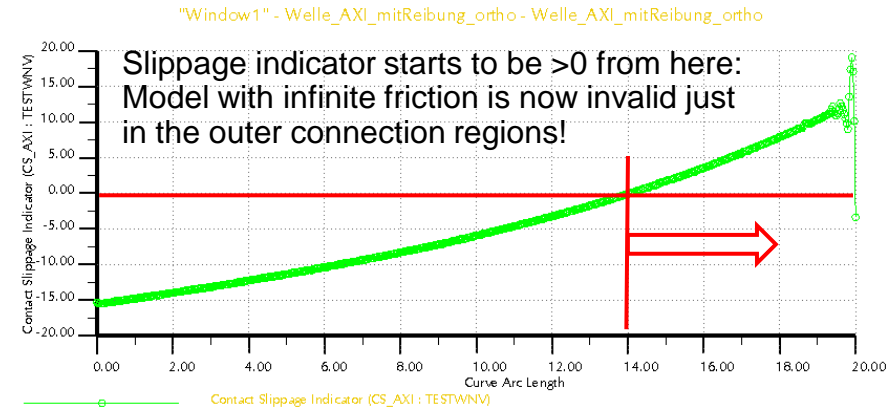

Contact Tangential Traction Magnitude (CS\_AXI : TESTWNV)  
 (tonne / (mm sec<sup>2</sup>))  
 Curve  
 Scale 1.0000E+00  
 Loadset:LoadSet2 : TESTWNV

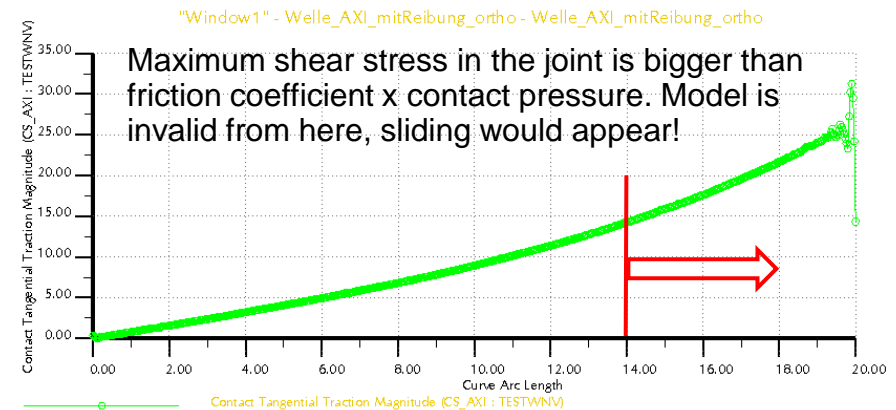

# Summary

---

## The contact model with infinite friction

- The new contact model with infinite friction is a very helpful extension of the existing, friction free contact model based on the penalty method
- Even though just an infinite friction coefficient is assumed, the specific quantities (contact shear stress, slippage indicator with real coefficient of friction) allow valuable conclusions about the behavior of the real contact
- But, because of the assumptions it is based on, the infinite friction contact model may also lead in certain cases to non-realistic results, so that here the simple contact model without friction can be the better approximation to reality! We can check if the validity of the infinite friction model is lost with help of the slippage indicators!

## In general, the following must be noted:

- Since contact analyses may become very complex (among other things due to the non-linear system to be solved), their processing is for sure no beginner's or occasional task!
- Deeper knowledge of the underlying theory (regarding software and structural mechanics) and user experience is necessary, even though the contact analysis is automated far-reaching, to obtain safe results!

## Informations about the Presenter

---

### Roland Jakel

- Dipl.-Ing. for mechanical engineering (Technische Universität Clausthal)
- Ph.-D. in design and analysis of engineering ceramics (FEM-Analysis with Marc/Mentat)
- 1996-2001 Employee at Dasa in Bremen (Daimler-Benz Aerospace, Product Division Space-Infrastructure, today EADS Astrium):
  - Structural simulation (FEM-Analysis with NASTRAN/PATRAN and Mechanica)
  - Project management for Ariane 5 Upper Stage „ESC-A“ Subsystems (Stage Damping System “SARO”, Inter Tank Structure)
- At the former DENC AG („Design ENgineering Consultants“) from 2001-2005 responsible for structural simulation services and education with the PTC simulation products (Mechanica, MDX, MDO, BMX)
- Since the DENC AG acquisition by PTC in 2005, Roland Jakel as principal consultant is responsible for the PTC simulation services within the Global Services Organization (GSO) for CER (Central Europe)